

# THIN FOOTPLATE KERRISON RONGEURS

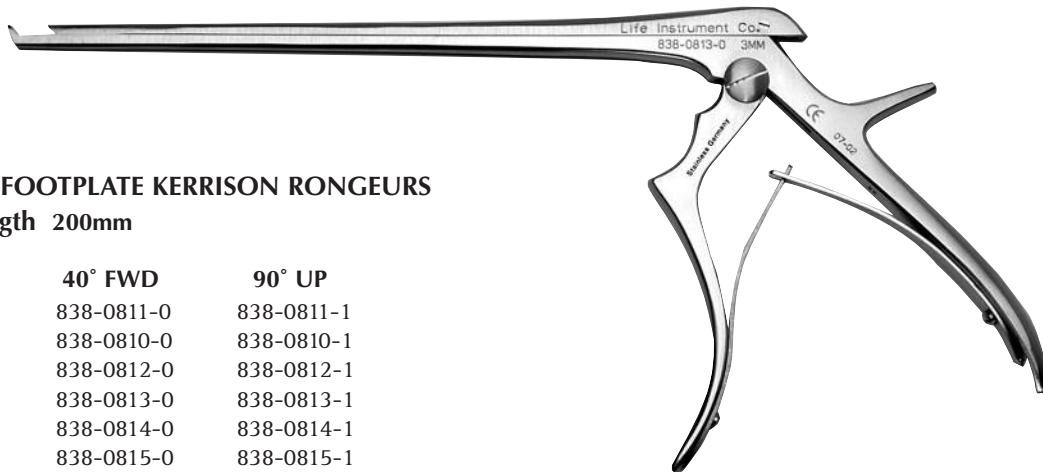

**THIN FOOTPLATE KERRISON RONGEURS**  
**8" length 200mm**

SIZE	40° FWD	90° UP
1mm	838-0811-0	838-0811-1
1.5mm	838-0810-0	838-0810-1
2mm	838-0812-0	838-0812-1
3mm	838-0813-0	838-0813-1
4mm	838-0814-0	838-0814-1
5mm	838-0815-0	838-0815-1

**7" length 175mm**

SIZE	40° FWD
1mm	838-0711-0
2mm	838-0712-0
3mm	838-0713-0
4mm	838-0714-0
5mm	838-0715-0

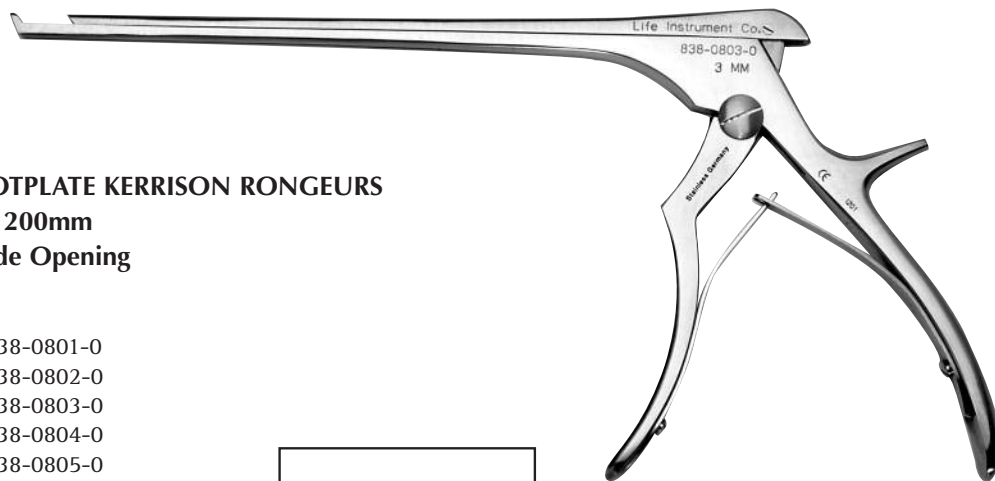

**THIN FOOTPLATE KERRISON RONGEURS**  
**8" length 200mm**  
**15mm Wide Opening**

SIZE	
1mm	838-0801-0
2mm	838-0802-0
3mm	838-0803-0
4mm	838-0804-0
5mm	838-0805-0

*Available with ring handle upon request - Add "R" to part # above.*

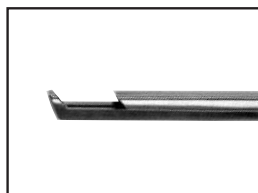

## THIN FOOTPLATE KERRISON RONGEURS



**THIN FOOTPLATE KERRISON RONGEURS**  
**8" length 200mm**  
**15mm Wide Opening Ceramic Coated**

**SIZE**

2mm	838-0802-0B
3mm	838-0803-0B
4mm	838-0804-0B
5mm	838-0805-0B

## ULTRA THIN FOOTPLATE KERRISON RONGEURS

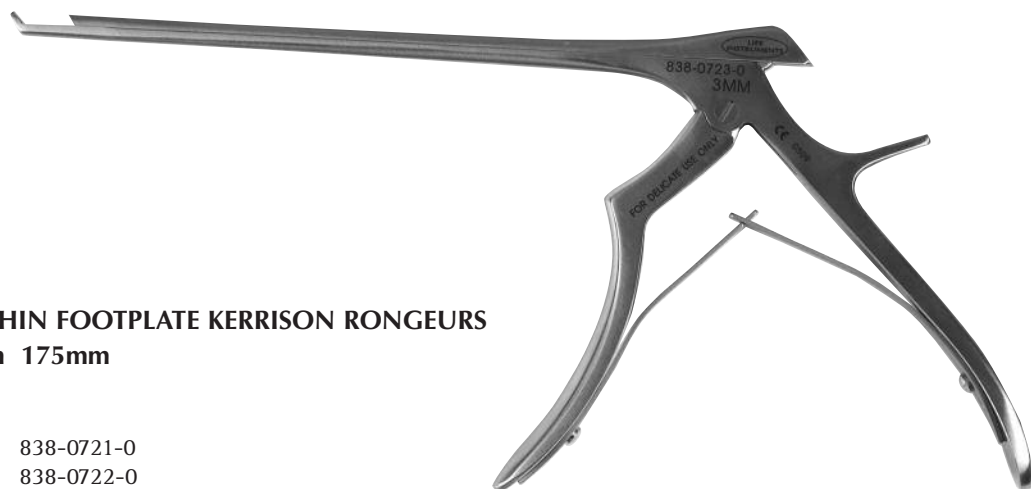

**ULTRA THIN FOOTPLATE KERRISON RONGEURS**  
**7" length 175mm**

**SIZE**

1mm	838-0721-0
2mm	838-0722-0
3mm	838-0723-0

**For Delicate Use Only**

## CERAMIC BONE EJECTING KERRISON RONGEURS



### CERAMIC BONE EJECTING KERRISON RONGEURS THIN FOOTPLATE 8" length 40° FWD 200mm

#### SIZE

2mm	837-8002-0
3mm	837-8003-0
4mm	837-8004-0
5mm	837-8005-0
6mm	837-8006-0

### CERAMIC KERRISON RONGEUR THIN FOOTPLATE 8" length 200mm

#### SIZE

1mm	837-8001-0
1.5mm	837-8015-0

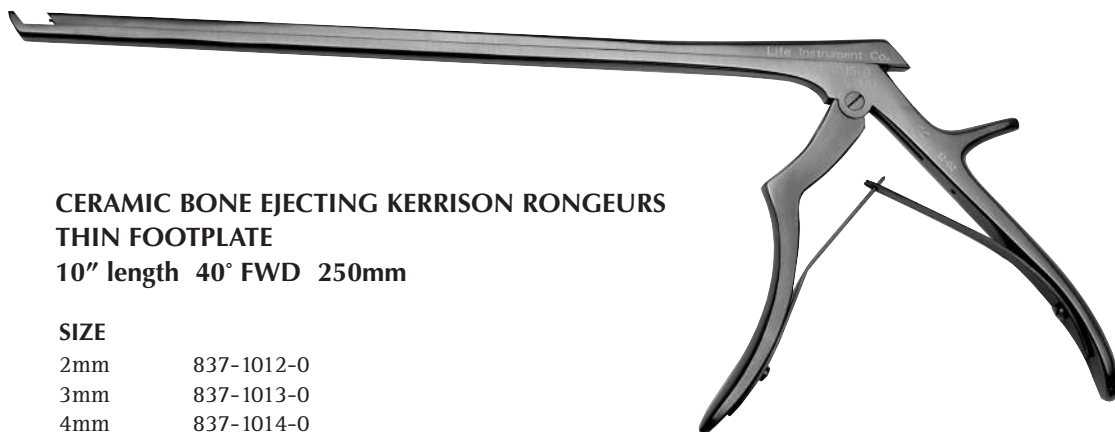

### CERAMIC BONE EJECTING KERRISON RONGEURS THIN FOOTPLATE 10" length 40° FWD 250mm

#### SIZE

2mm	837-1012-0
3mm	837-1013-0
4mm	837-1014-0
5mm	837-1015-0

## OPEN UP KERRISON RONGEURS



**8" OPEN UP KERRISONS  
THIN FOOTPLATE**  
8" overall length 200mm

**SIZE**

1mm	830-0801-0A
2mm	830-0802-0A
3mm	830-0803-0A
4mm	830-0804-0A
5mm	830-0805-0A

*Easy to Disassemble • Great for Cleaning*



**8" OPEN UP KERRISON STERILIZATION TRAY WITH COVER**

Holds 5 Open Up Kerrisons  
Outer Dimensions: 10" x 21.5" x 1.5"

702-2110-1

# OPEN UP KERRISON RONGEURS



## 10" & 12" OPEN UP KERRISONS

10" overall length 250mm  
THIN FOOTPLATE

SIZE	40° FWD
1mm	830-1001-0A
2mm	830-1002-0A
3mm	830-1003-0A
4mm	830-1004-0A
5mm	830-1005-0A

12" overall length 300mm

SIZE	40° FWD
2mm	830-1202-0A
3mm	830-1203-0A
4mm	830-1204-0A

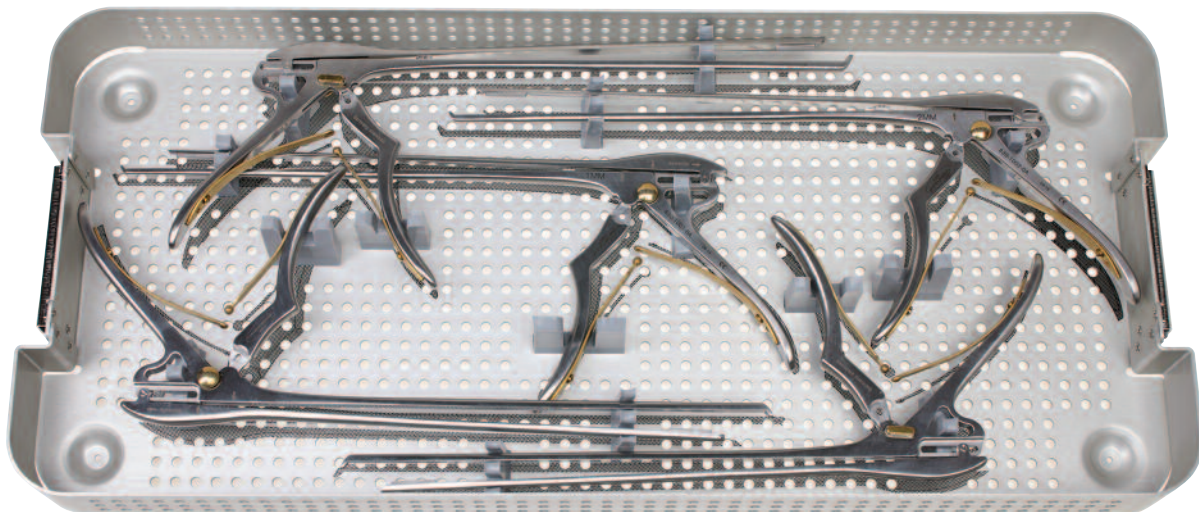

## OPEN UP KERRISON STERILIZATION TRAY WITH COVER

Holds 5 each 10" Open Up Kerrisons  
Or 3 each 12" Open Up Kerrisons  
Outer Dimensions: 10" x 21.5" x 2"

702-2112-1

TO ORDER, CALL 800-925-2995

## CERAMIC OPEN UP KERRISON RONGEURS



**CERAMIC OPEN UP KERRISON RONGEURS  
THIN FOOTPLATE  
8" length 200mm 40° FWD**

**SIZE**

1mm	830-0801-0AB
2mm	830-0802-0AB
3mm	830-0803-0AB
4mm	830-0804-0AB
5mm	830-0805-0AB

## CERAMIC BAYONET OPEN UP KERRISONS



**CERAMIC BAYONET OPEN UP KERRISONS  
THIN FOOTPLATE  
6.75" working length 170mm 40° FWD**

**SIZE**

1mm	837-0901-0A
2mm	837-0902-0A
3mm	837-0903-0A
4mm	837-0904-0A



## CERAMIC EJECTOR KERRISON RONGEURS

**CERAMIC KERRISON RONGEURS  
WITH SIDE SLIDING EJECTOR**  
8" length 40° FWD 200mm

**SIZE**

1mm	830-8001-0B
2mm	830-8002-0B
3mm	830-8003-0B
4mm	830-8004-0B
5mm	830-8005-0B



## EJECTOR KERRISON RONGEURS

**KERRISON RONGEURS  
WITH SIDE SLIDING EJECTOR**  
8" length 40° FWD 200mm

**SIZE**

1mm	830-8001-0
2mm	830-8002-0
3mm	830-8003-0
4mm	830-8004-0
5mm	830-8005-0

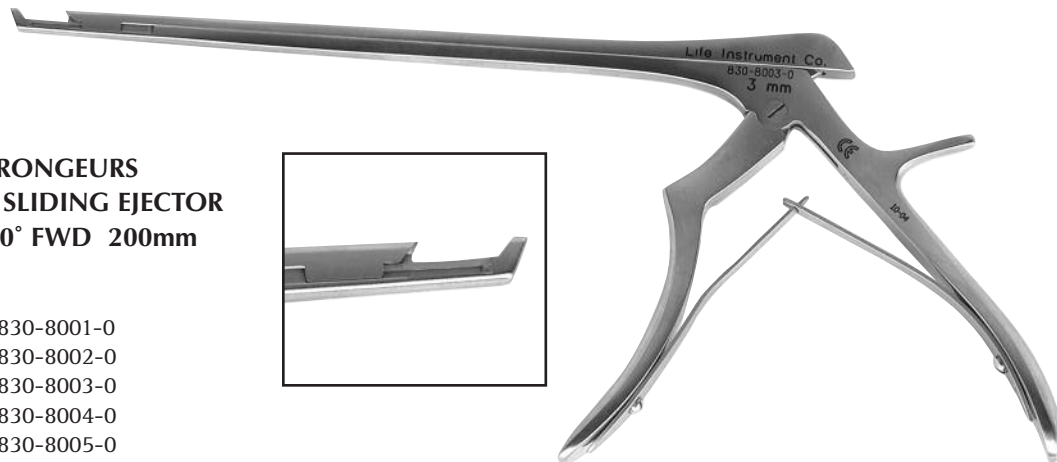
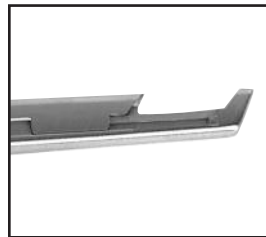

## SCREWDRIVERS



**SCREWDRIVERS**  
9.5" length

.215 x .020 Blade	830-9500-0
.120 x .020 Blade	830-9501-0

TO ORDER, CALL **800-925-2995**

## KERRISON RONGEURS

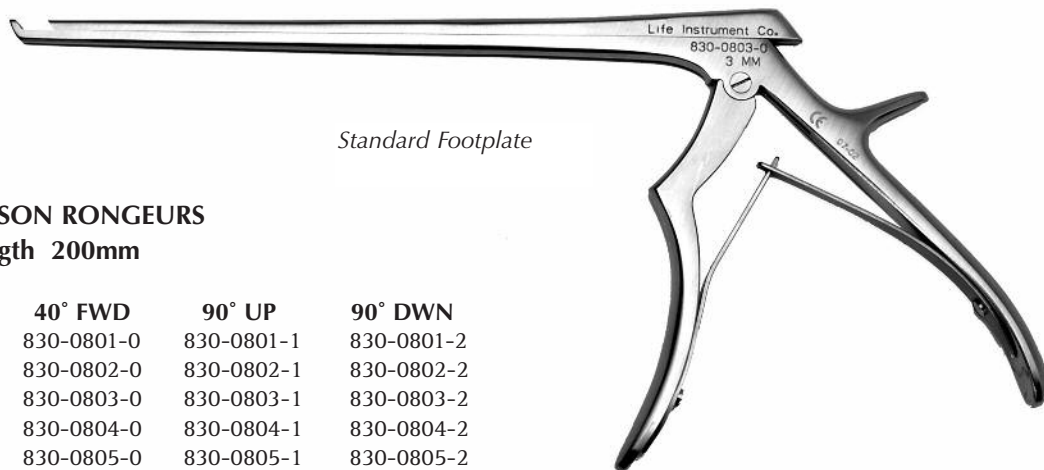

*Standard Footplate*

### KERRISON RONGEURS 8" length 200mm

SIZE	40° FWD	90° UP	90° DWN
1mm	830-0801-0	830-0801-1	830-0801-2
2mm	830-0802-0	830-0802-1	830-0802-2
3mm	830-0803-0	830-0803-1	830-0803-2
4mm	830-0804-0	830-0804-1	830-0804-2
5mm	830-0805-0	830-0805-1	830-0805-2
6mm	830-0806-0	830-0806-1	830-0806-2



All Rongeurs are Etched on Top of Shaft  
for Easy Viewing by Surgeon.

## TRAY

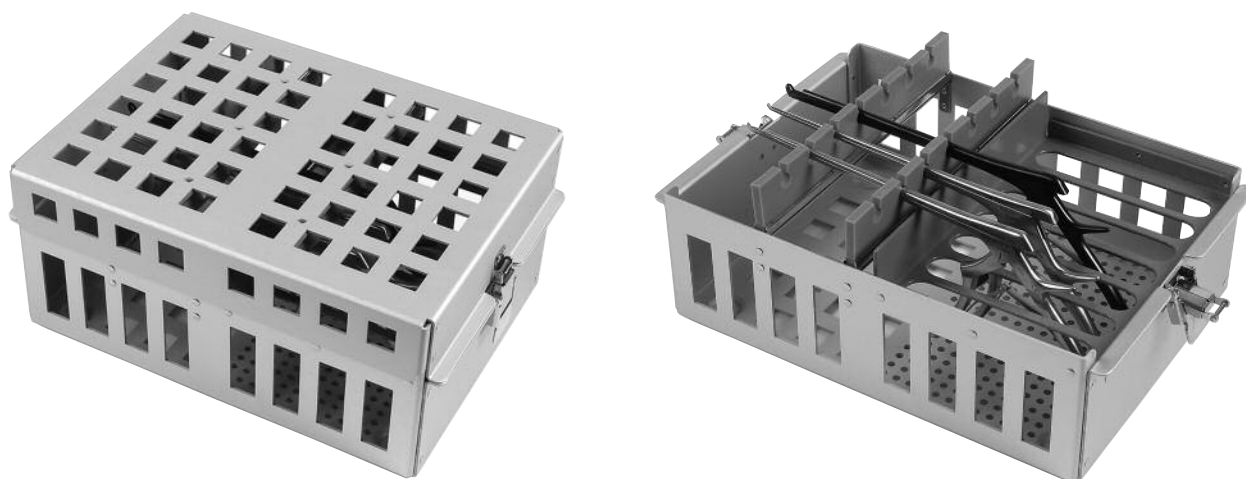

### KERRISON INSTRUMENT TRAY

Holds 7 Kerrisons

702-8317-0



# ANTERIOR KERRISON RONGEURS

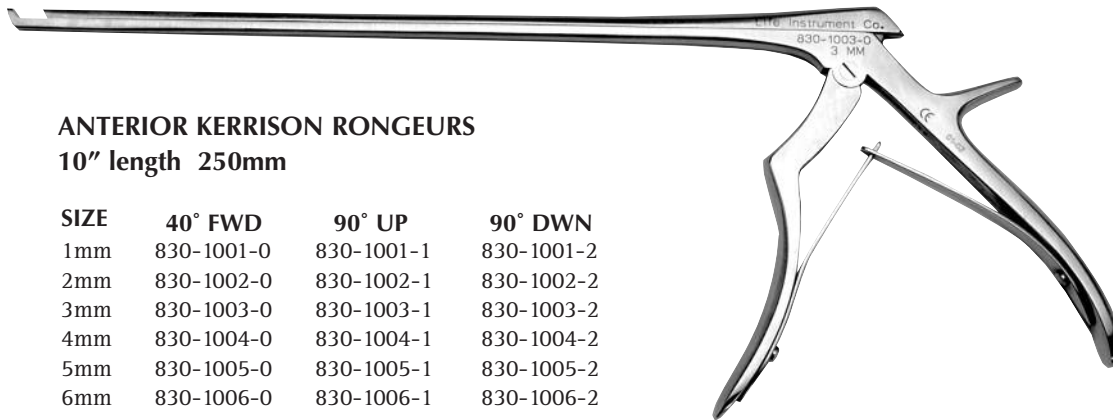

**ANTERIOR KERRISON RONGEURS**  
**10" length 250mm**

SIZE	40° FWD	90° UP	90° DWN
1mm	830-1001-0	830-1001-1	830-1001-2
2mm	830-1002-0	830-1002-1	830-1002-2
3mm	830-1003-0	830-1003-1	830-1003-2
4mm	830-1004-0	830-1004-1	830-1004-2
5mm	830-1005-0	830-1005-1	830-1005-2
6mm	830-1006-0	830-1006-1	830-1006-2

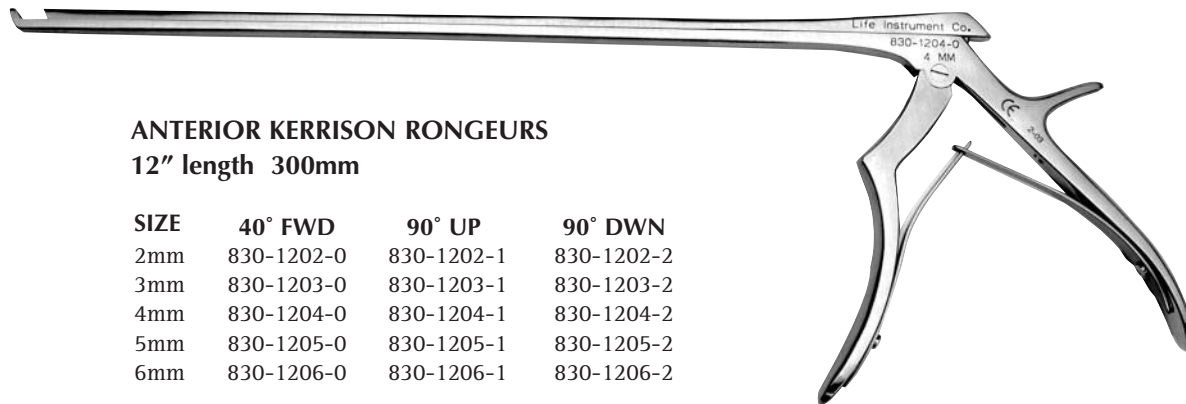

**ANTERIOR KERRISON RONGEURS**  
**12" length 300mm**

SIZE	40° FWD	90° UP	90° DWN
2mm	830-1202-0	830-1202-1	830-1202-2
3mm	830-1203-0	830-1203-1	830-1203-2
4mm	830-1204-0	830-1204-1	830-1204-2
5mm	830-1205-0	830-1205-1	830-1205-2
6mm	830-1206-0	830-1206-1	830-1206-2

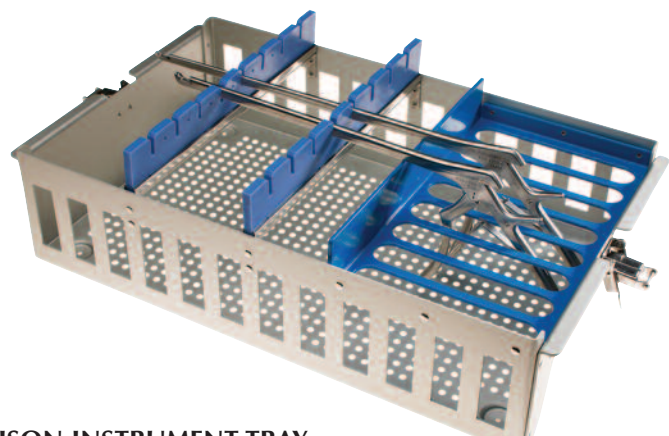
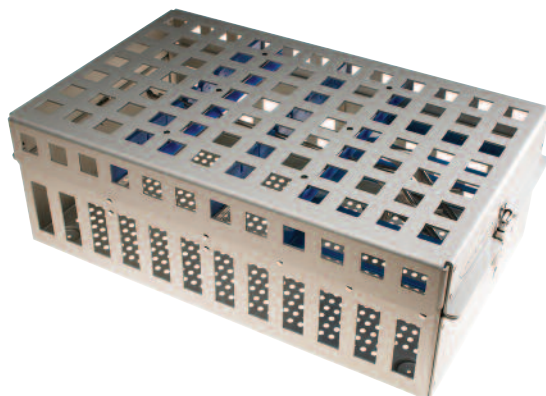

## ANTERIOR KERRISON INSTRUMENT TRAY

Holds 7 each 10" or 12" Anterior Kerrisons

702-1228-0

TO ORDER, CALL 800-925-2995

## FORAMINOTOMY RONGEURS

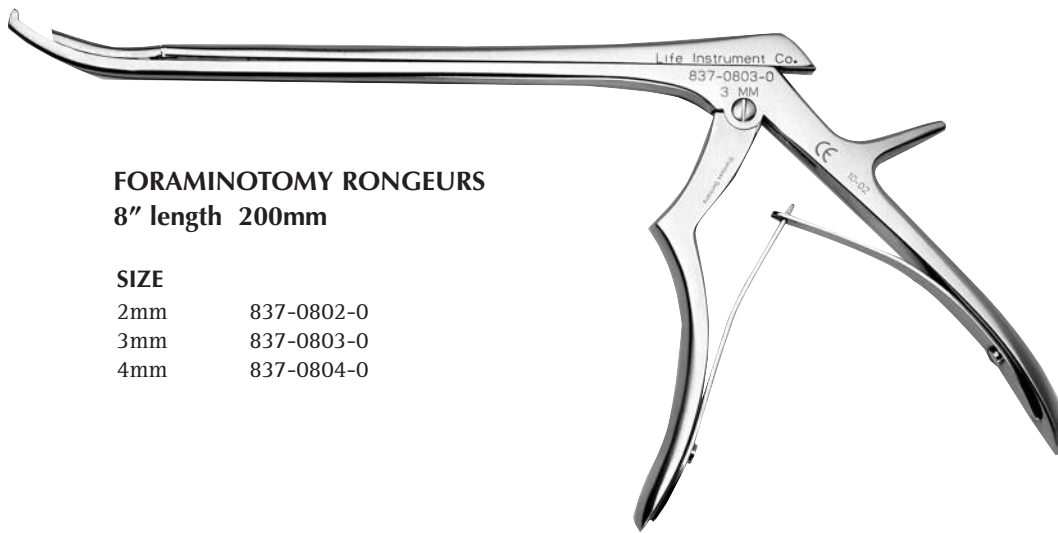

**FORAMINOTOMY RONGEURS**  
8" length 200mm

**SIZE**

2mm	837-0802-0
3mm	837-0803-0
4mm	837-0804-0

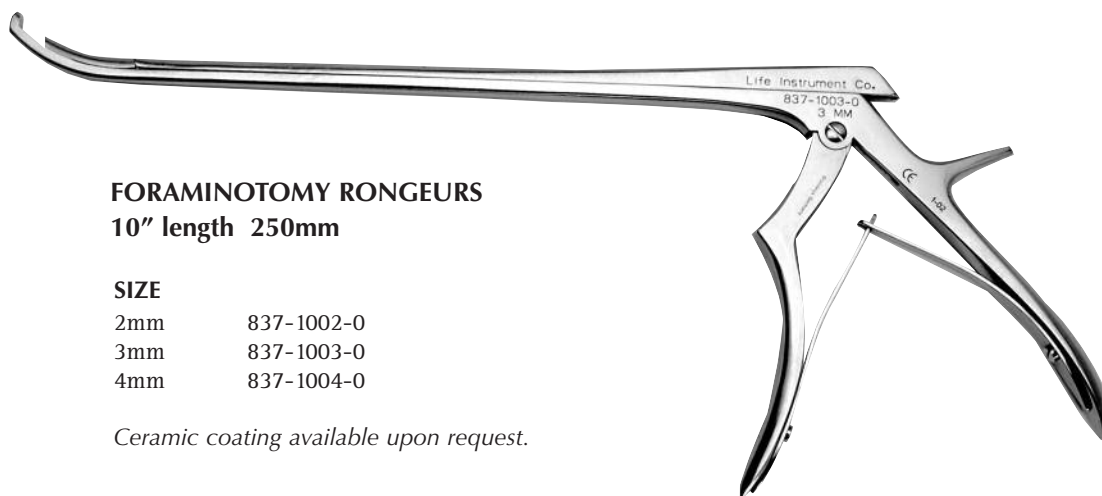

**FORAMINOTOMY RONGEURS**  
10" length 250mm

**SIZE**

2mm	837-1002-0
3mm	837-1003-0
4mm	837-1004-0

*Ceramic coating available upon request.*

## ANTERIOR KERRISON RONGEURS

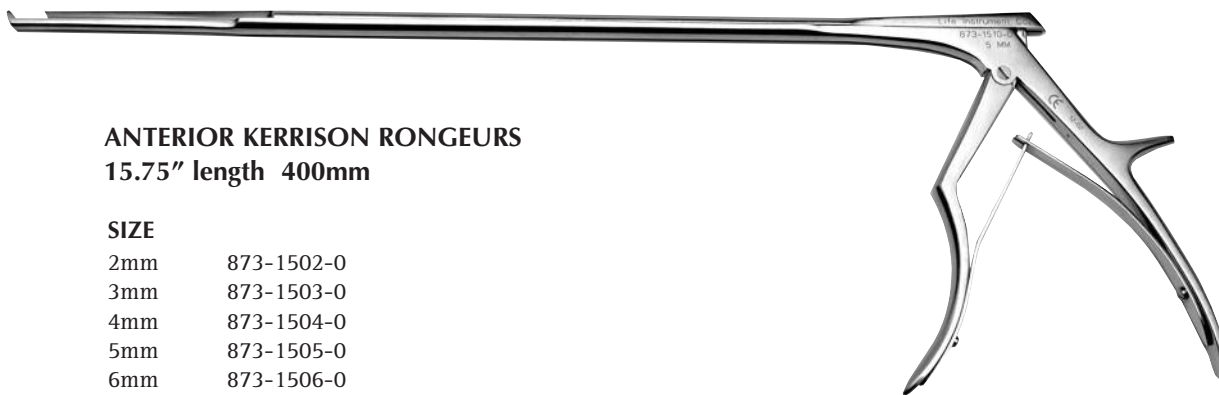

**ANTERIOR KERRISON RONGEURS**  
15.75" length 400mm

**SIZE**

2mm	873-1502-0
3mm	873-1503-0
4mm	873-1504-0
5mm	873-1505-0
6mm	873-1506-0
7mm	873-1507-0

## SPURLING KERRISON RONGEURS

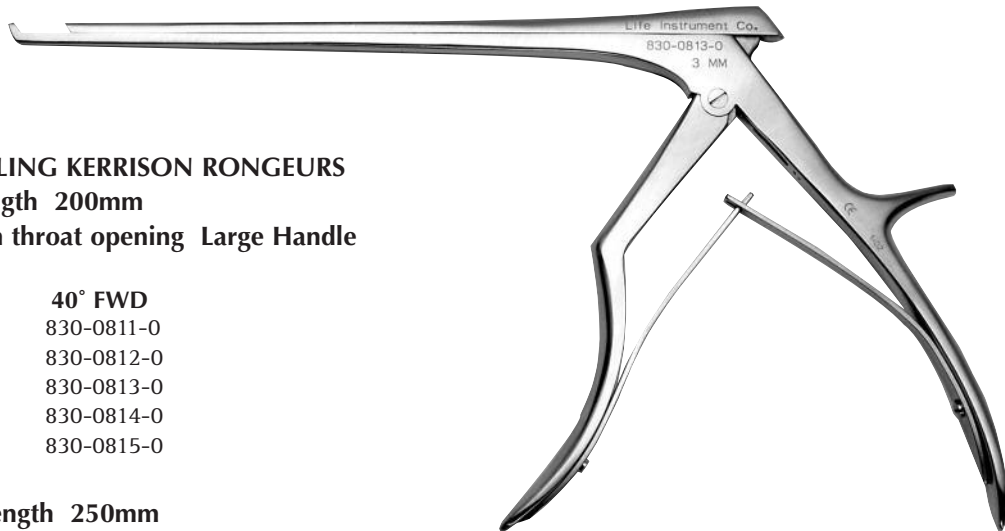

**SPURLING KERRISON RONGEURS**  
**8" length 200mm**  
**15mm throat opening Large Handle**

SIZE	40° FWD
1mm	830-0811-0
2mm	830-0812-0
3mm	830-0813-0
4mm	830-0814-0
5mm	830-0815-0

**10" length 250mm**

SIZE	40° FWD
2mm	830-1012-0
3mm	830-1013-0
4mm	830-1014-0
5mm	830-1015-0

## GERARD RONGEURS

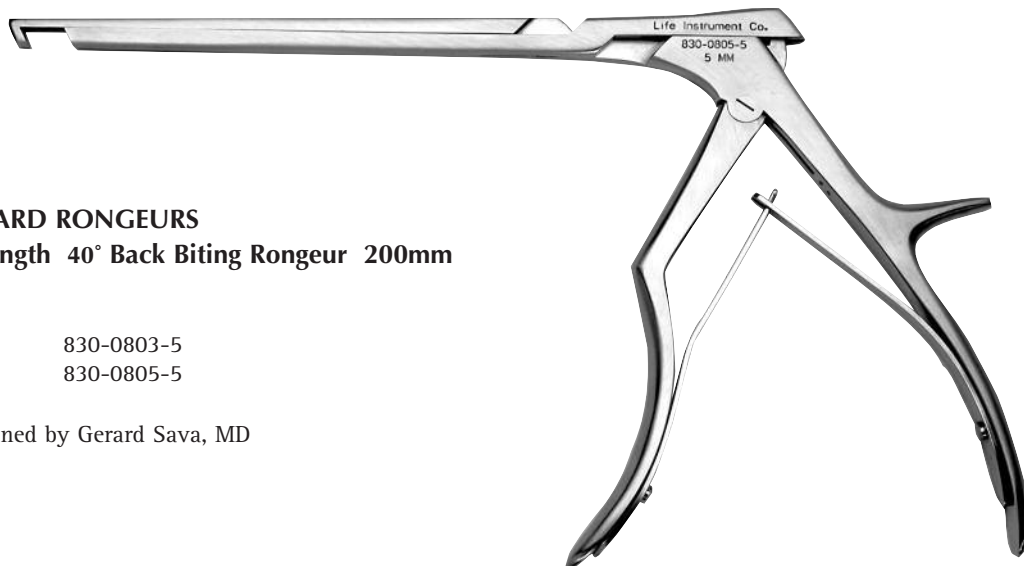

**GERARD RONGEURS**  
**8" length 40° Back Biting Rongeur 200mm**

SIZE	
3mm	830-0803-5
5mm	830-0805-5

Designed by Gerard Sava, MD

## FERRIS SMITH PITUITARY RONGEURS

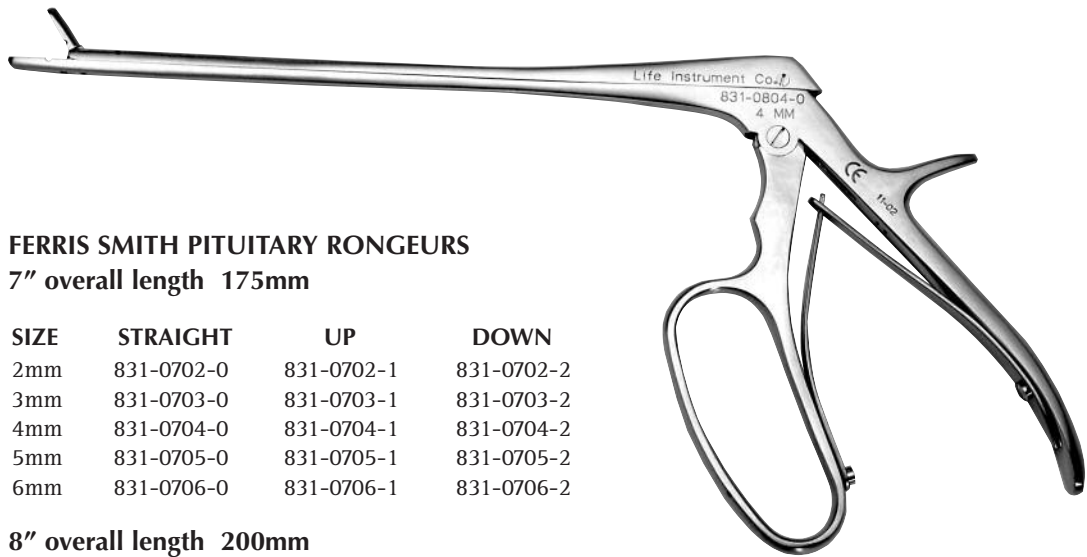

### FERRIS SMITH PITUITARY RONGEURS

7" overall length 175mm

SIZE	STRAIGHT	UP	DOWN
2mm	831-0702-0	831-0702-1	831-0702-2
3mm	831-0703-0	831-0703-1	831-0703-2
4mm	831-0704-0	831-0704-1	831-0704-2
5mm	831-0705-0	831-0705-1	831-0705-2
6mm	831-0706-0	831-0706-1	831-0706-2

8" overall length 200mm

SIZE	STRAIGHT	UP	DOWN
2mm	831-0802-0	831-0802-1	831-0802-2
3mm	831-0803-0	831-0803-1	831-0803-2
4mm	831-0804-0	831-0804-1	831-0804-2
5mm	831-0805-0	831-0805-1	831-0805-2
6mm	831-0806-0	831-0806-1	831-0806-2

## FERRIS SMITH PITUITARY/FORAMINOTOMY DESIGN

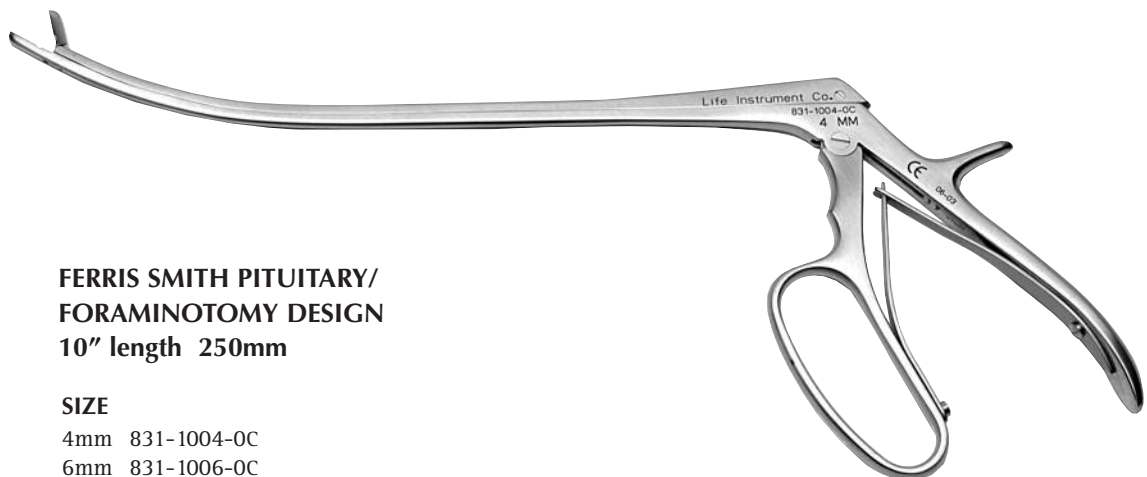

### FERRIS SMITH PITUITARY/ FORAMINOTOMY DESIGN

10" length 250mm

#### SIZE

4mm	831-1004-0C
6mm	831-1006-0C

*Custom bends available upon request.*

## ANTERIOR FERRIS SMITH PITUITARY RONGEURS

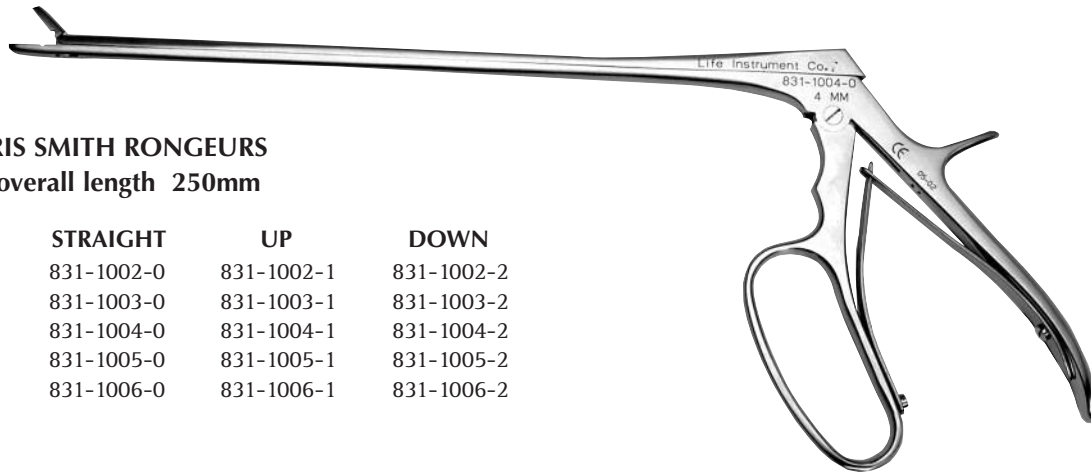

### FERRIS SMITH RONGEURS 10" overall length 250mm

SIZE	STRAIGHT	UP	DOWN
2mm	831-1002-0	831-1002-1	831-1002-2
3mm	831-1003-0	831-1003-1	831-1003-2
4mm	831-1004-0	831-1004-1	831-1004-2
5mm	831-1005-0	831-1005-1	831-1005-2
6mm	831-1006-0	831-1006-1	831-1006-2

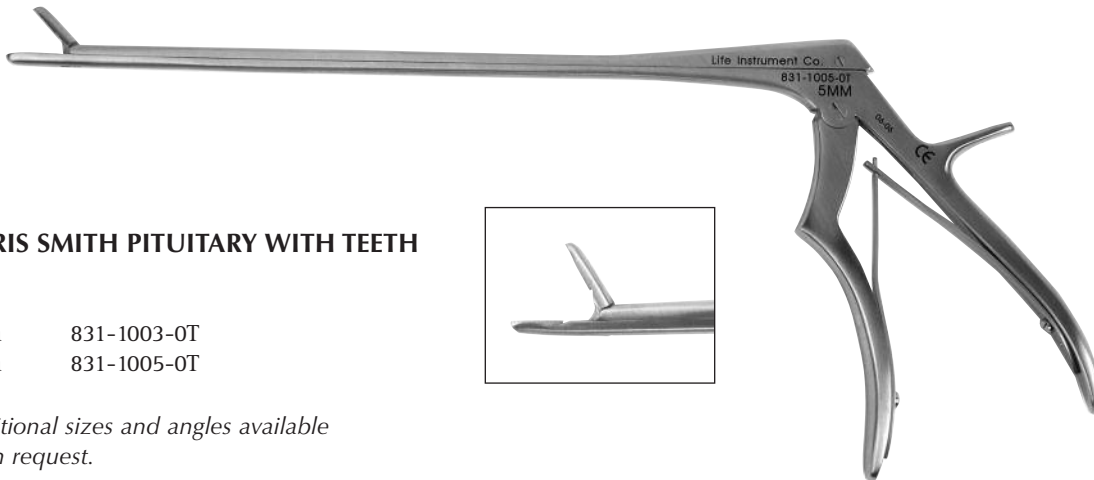

### FERRIS SMITH PITUITARY WITH TEETH

SIZE	
3mm	831-1003-0T
5mm	831-1005-0T

*Additional sizes and angles available upon request.*

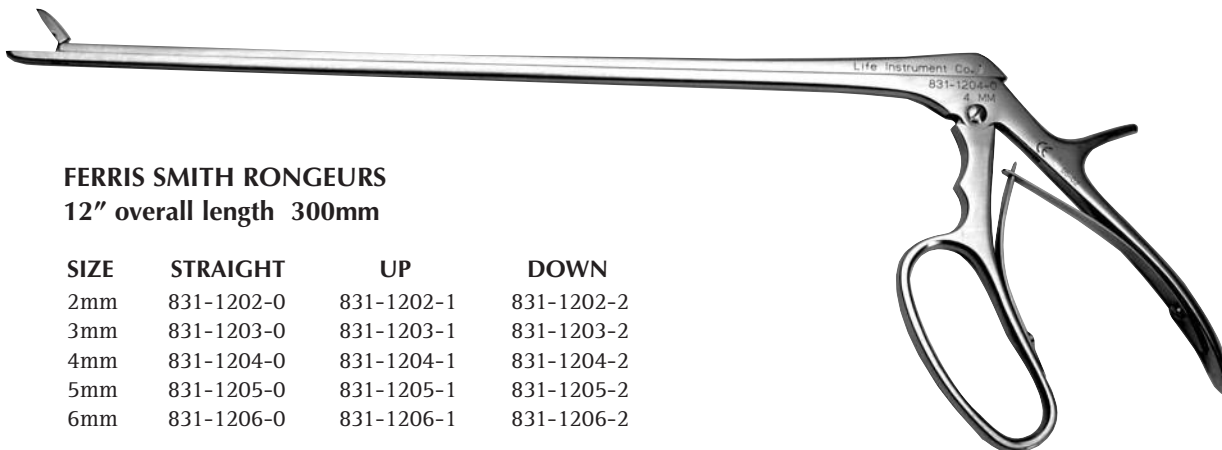

### FERRIS SMITH RONGEURS 12" overall length 300mm

SIZE	STRAIGHT	UP	DOWN
2mm	831-1202-0	831-1202-1	831-1202-2
3mm	831-1203-0	831-1203-1	831-1203-2
4mm	831-1204-0	831-1204-1	831-1204-2
5mm	831-1205-0	831-1205-1	831-1205-2
6mm	831-1206-0	831-1206-1	831-1206-2

TO ORDER, CALL 800-925-2995

# INTERVERTEBRAL DISCECTOMY RONGEURS

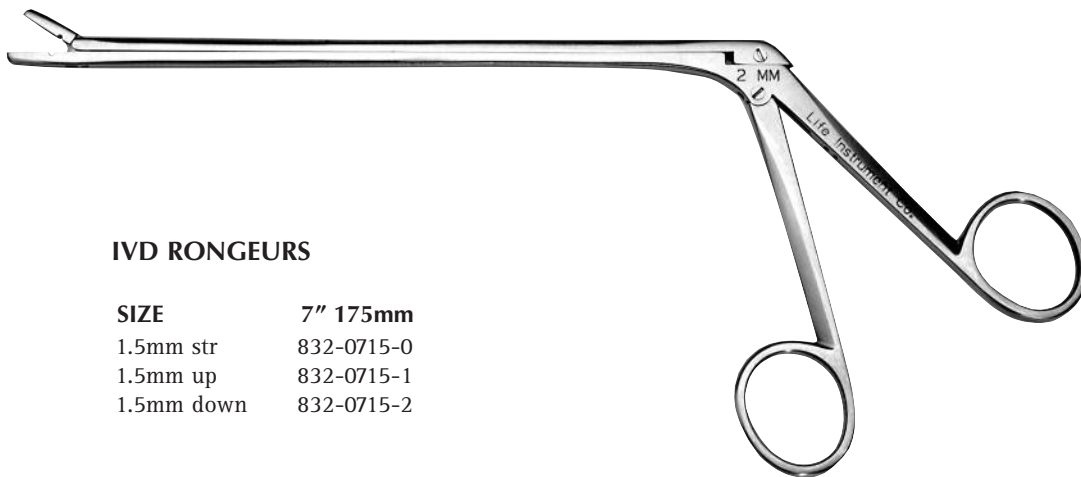

## IVD RONGEURS

SIZE	7" 175mm
1.5mm str	832-0715-0
1.5mm up	832-0715-1
1.5mm down	832-0715-2

## CUSHING IVD RONGEURS 2 X 10MM

SIZE	7" 175mm	9" 230mm
2mm str	832-0702-0	832-0902-0
2mm up	832-0702-1	832-0902-1
2mm dwn	832-0702-2	832-0902-2

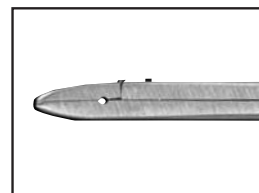

STRAIGHT

## LOVE IVD RONGEURS 3 X 10MM

SIZE	7" 175mm	9" 230mm
3mm str	832-0703-0	832-0903-0
3mm up	832-0703-1	832-0903-1
3mm dwn	832-0703-2	832-0903-2

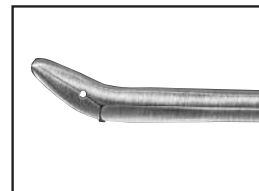

UP

## SPURLING IVD RONGEURS 4 X 10MM

SIZE	7" 175mm	9" 230mm
4mm str	832-0704-0	832-0904-0
4mm up	832-0704-1	832-0904-1
4mm dwn	832-0704-2	832-0904-2

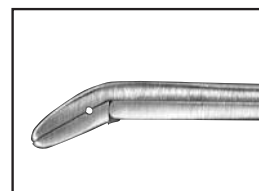

DOWN

## CASPAR STYLE IVD PITUITARY Teeth on back of Cup Fenestrated Cup

SIZE	7" 175mm
2mm	832-0702-0C
3mm	832-0703-0C
4mm	832-0704-0C

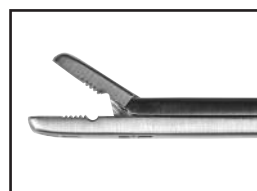



# MICRO PITUITARY RONGEURS

## MICRO DECKER PITUITARY RONGEURS 6" length 150mm

	SIZE	STRAIGHT	UP	LEFT	RIGHT	DOWN
Delicate	1.5mm	839-0601-0	839-0601-1	839-0601-3	839-0601-4	839-0602-2
Standard	2mm	839-0602-0	839-0602-1			
With Teeth	2mm	839-0602-0T				

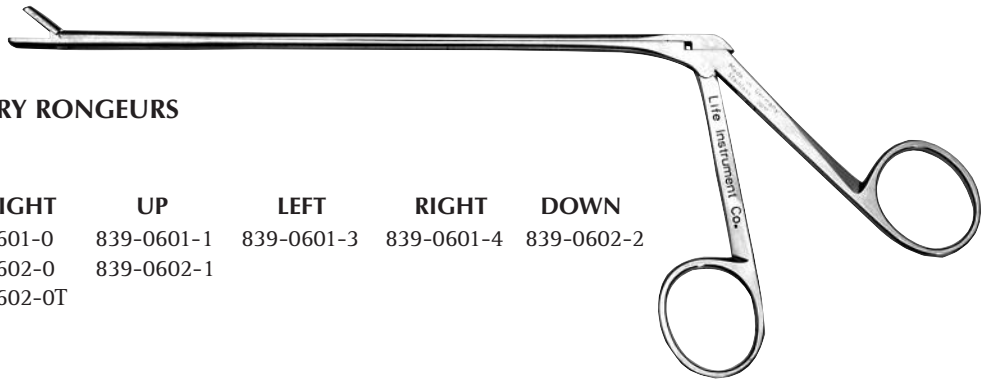

## MICRO DECKER PITUITARY RONGEURS 8" length 200mm

	SIZE	STRAIGHT	UP	LEFT	RIGHT	DOWN BITE
Standard	2mm	839-0802-0	839-0802-1	839-0802-3	839-0802-4	839-0802-2
With Teeth	2mm	839-0802-0T				

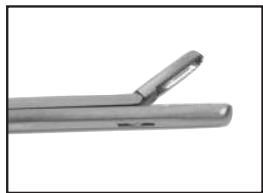

TEETH



UP BITE

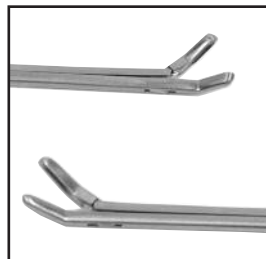

LEFT & RIGHT

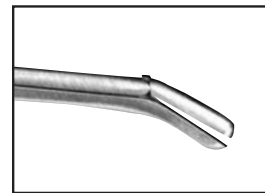

DOWN BITE

# PEAPOD RONGEURS

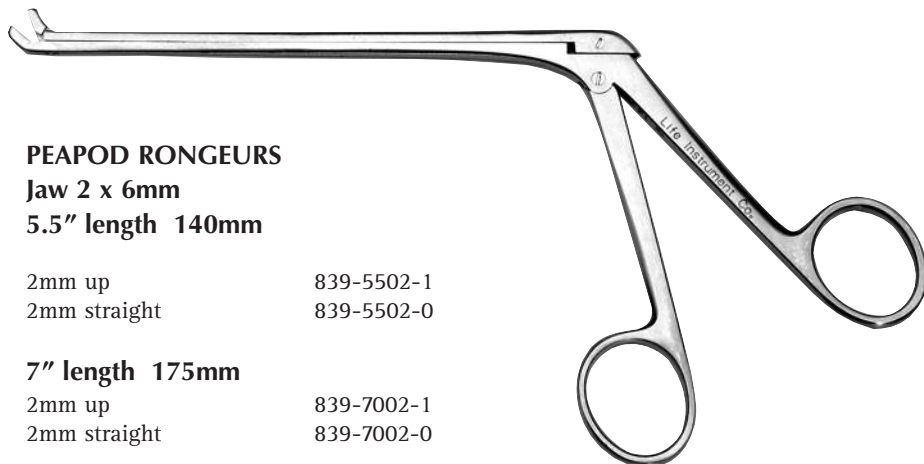

## PEAPOD RONGEURS Jaw 2 x 6mm 5.5" length 140mm

2mm up	839-5502-1
2mm straight	839-5502-0

## 7" length 175mm

2mm up	839-7002-1
2mm straight	839-7002-0

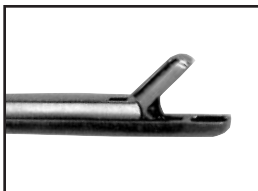

## WILLIAMS PITUITARY RONGEURS

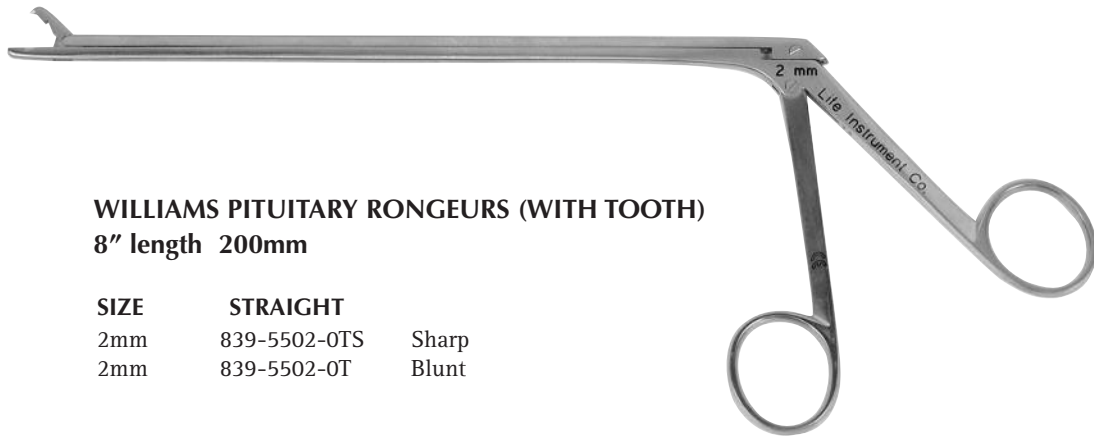

**WILLIAMS PITUITARY RONGEURS (WITH TOOTH)**  
8" length 200mm

SIZE	STRAIGHT		
2mm	839-5502-OTS	Sharp	
2mm	839-5502-OT	Blunt	

## TOOTHED PITUITARY IVD RONGEURS

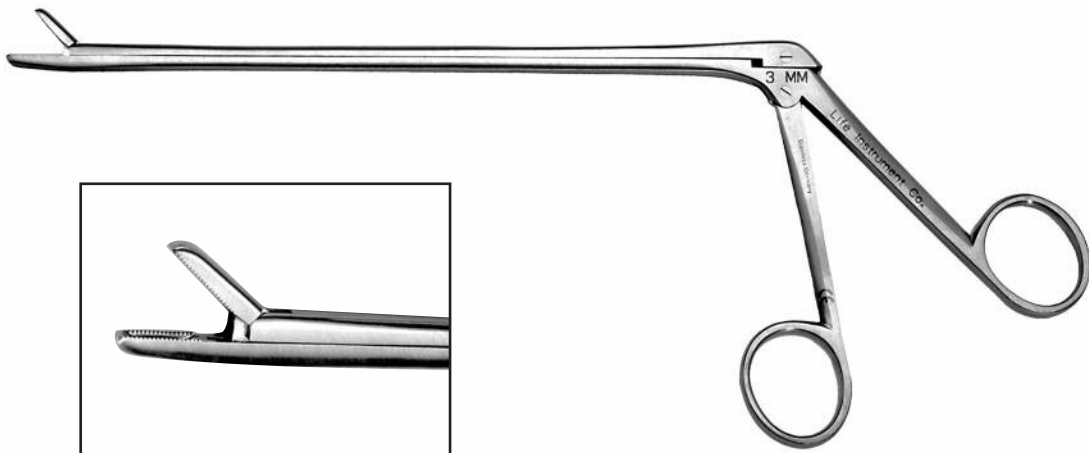

**TOOTHED PITUITARY IVD RONGEURS**  
8" length 200mm

SIZE	STRAIGHT	UP	DOWN BITE
1.5mm	732-8015-0	732-8015-1	732-8015-2
2mm	732-8020-0	732-8020-1	732-8020-2
3mm	732-8030-0	732-8030-1	732-8030-2
4mm	732-8040-0	732-8040-1	732-8040-2
5mm	732-8050-0	732-8050-1	732-8050-2

# TOOTHED PITUITARY RONGEURS

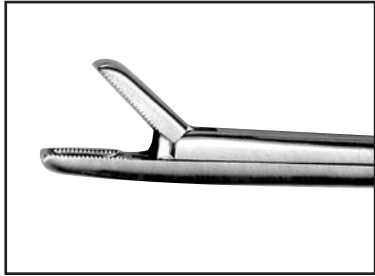
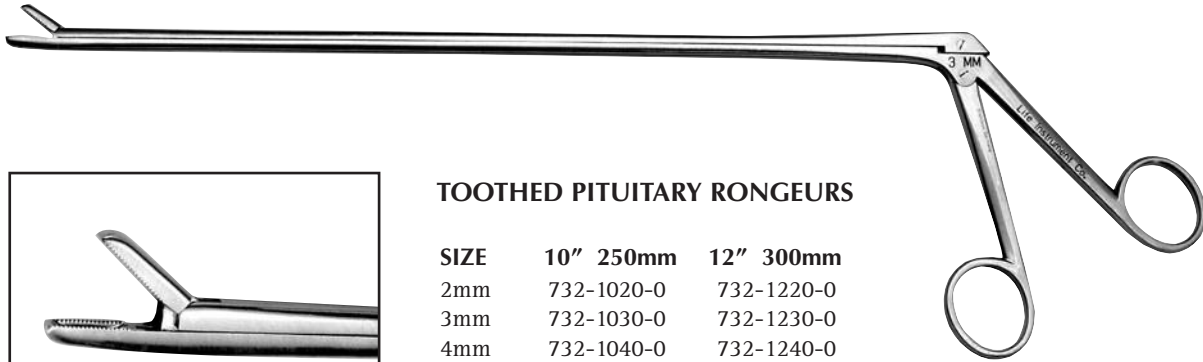

## TOOTHED PITUITARY RONGEURS

SIZE	10" 250mm	12" 300mm
2mm	732-1020-0	732-1220-0
3mm	732-1030-0	732-1230-0
4mm	732-1040-0	732-1240-0
5mm	732-1050-0	732-1250-0

# TOOTHED GRASPING FORCEP

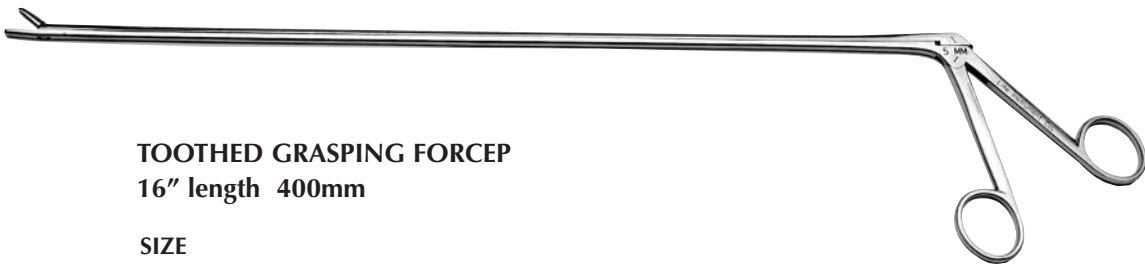

## TOOTHED GRASPING FORCEP 16" length 400mm

SIZE	
5mm	873-1605-0

# DISC RONGEURS



## DISC RONGEURS 10" overall length 250 mm

Straight Shaft	831-1024-0
Curved Shaft	831-1024-0C

## ANTERIOR VERTEBRAL BODY RONGEURS

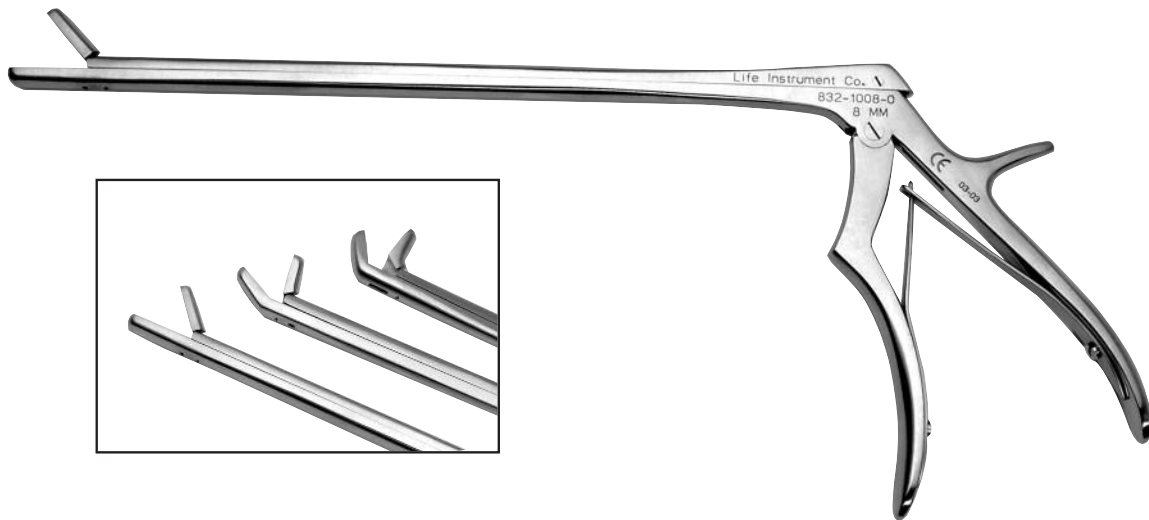

### HODGSON STYLE

#### 10" length 250mm

8mm Straight	832-1008-0
8mm Angled 30° up	832-1008-1
8mm Angled 60° up	832-1008-2
8mm Straight with Teeth	832-1018-0

#### 12" length 300mm

8mm Straight	832-1208-0
8mm Straight with Teeth	832-1218-0

## ANTERIOR DISC RONGEURS

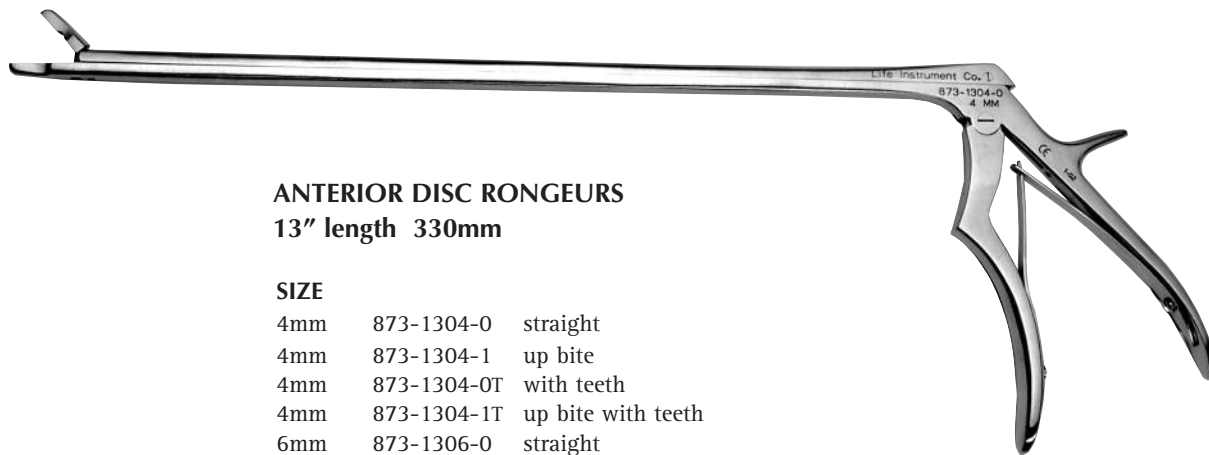

### ANTERIOR DISC RONGEURS

#### 13" length 330mm

#### SIZE

4mm	873-1304-0	straight
4mm	873-1304-1	up bite
4mm	873-1304-0T	with teeth
4mm	873-1304-1T	up bite with teeth
6mm	873-1306-0	straight

## ANTERIOR PITUITARY RONGEURS

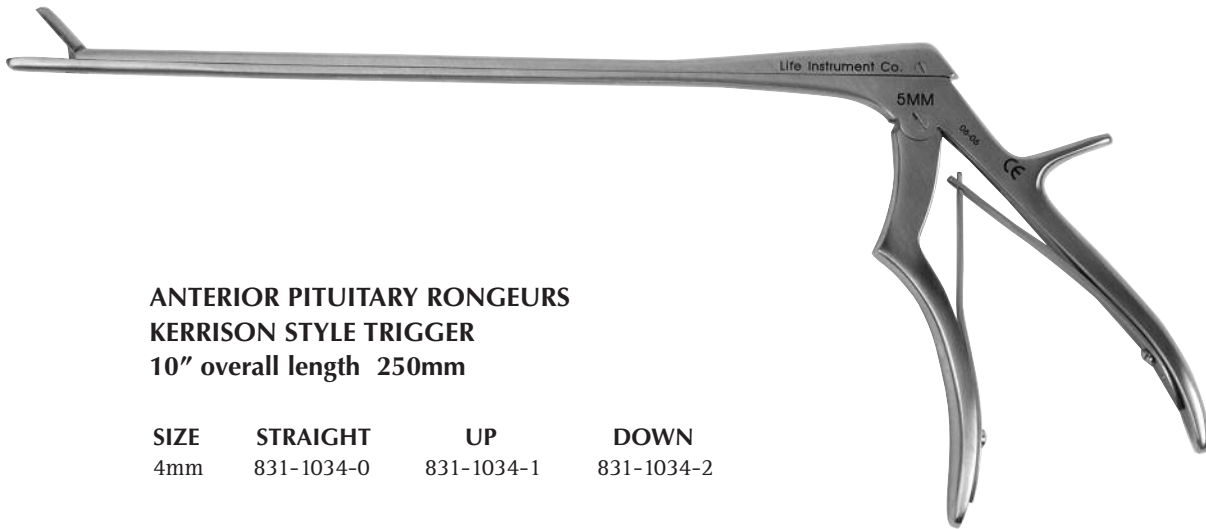

**ANTERIOR PITUITARY RONGEURS  
KERRISON STYLE TRIGGER**  
10" overall length 250mm

SIZE	STRAIGHT	UP	DOWN
4mm	831-1034-0	831-1034-1	831-1034-2

12" overall length 300mm

SIZE	STRAIGHT	UP	DOWN
4mm	831-1234-0	831-1234-1	831-1234-2

## LATERAL CURVE PITUITARY RONGEURS

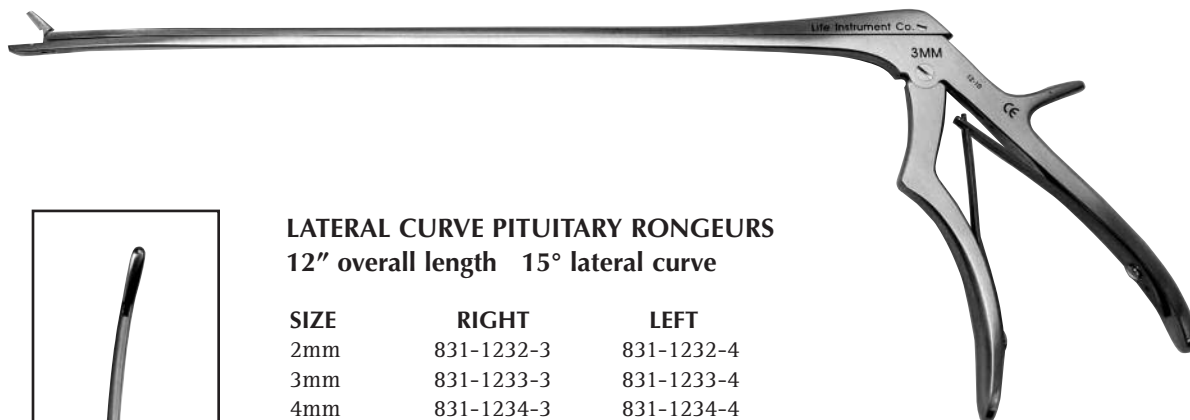

**LATERAL CURVE PITUITARY RONGEURS**  
12" overall length 15° lateral curve

SIZE	RIGHT	LEFT
2mm	831-1232-3	831-1232-4
3mm	831-1233-3	831-1233-4
4mm	831-1234-3	831-1234-4

## DURASAFE RONGEUR



**DURASAFE RONGEUR**  
**Reverse Biting Action Rongeur**  
**10" overall length 250mm**

**SIZE**

2mm	830-1032-0
3mm	830-1033-0
4mm	830-1034-0

**Instrument can be opened up for cleaning.**

**\* NEW \***

The reverse biting mechanism prevents dural entrapment between the footplate and the cutting element while allowing the surgeon to operate the rongeur identically to a standard Kerrison. DuraSafe Rongeurs now allow a surgeon to remove soft tissue and bone away from the dura and other sensitive spine structures.

DuraSafe offers protection from iatrogenic injury to the neural structures while performing complex spinal procedures.

Designed by Nikhil Thakur, MD and David Paller, MS, MBA



## BAYONET KERRISON RONGEURS

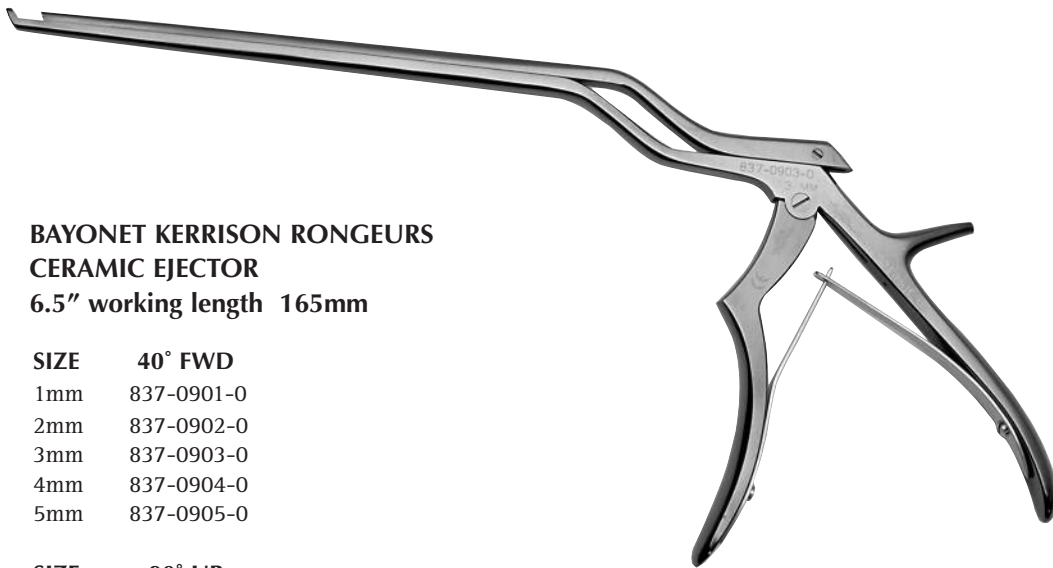

### BAYONET KERRISON RONGEURS CERAMIC EJECTOR

6.5" working length 165mm

#### SIZE 40° FWD

1mm	837-0901-0
2mm	837-0902-0
3mm	837-0903-0
4mm	837-0904-0
5mm	837-0905-0

#### SIZE 90° UP

2mm	837-0902-1
3mm	837-0903-1
4mm	837-0904-1

See page 3.6 for Open Up Bayonet Kerrison.

## BAYONET PITUITARY RONGEURS

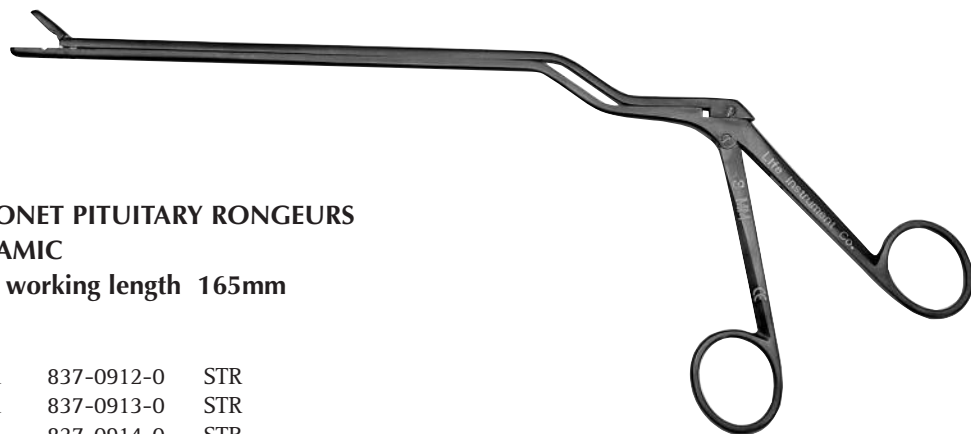

### BAYONET PITUITARY RONGEURS CERAMIC

6.5" working length 165mm

#### SIZE

2mm	837-0912-0	STR
3mm	837-0913-0	STR
4mm	837-0914-0	STR

2mm	837-0912-1	UP
3mm	837-0913-1	UP
4mm	837-0914-1	UP

Downbite Pituitary available upon request.

## LEKSELL RONGEURS



### LEKSELL RONGEURS 9" length 230mm

SIZE	SLIGHT CURVE	FULL CURVE
2mm	834-0902-0	834-0902-1
4mm	834-0914-0	834-0914-1
8mm	834-0918-0	834-0918-1

### FLAT NOSE LEKSELL (see inset)

SIZE	
8mm	834-0928-0



Excellent for removing osteophytes.

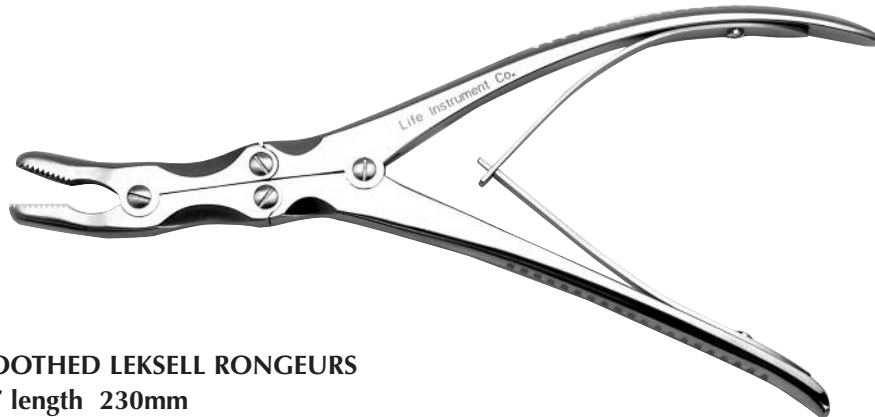

### TOOTHED LEKSELL RONGEURS 9" length 230mm

SIZE	
4mm	834-0904-0
8mm	834-0908-0



## ADSON RONGEURS

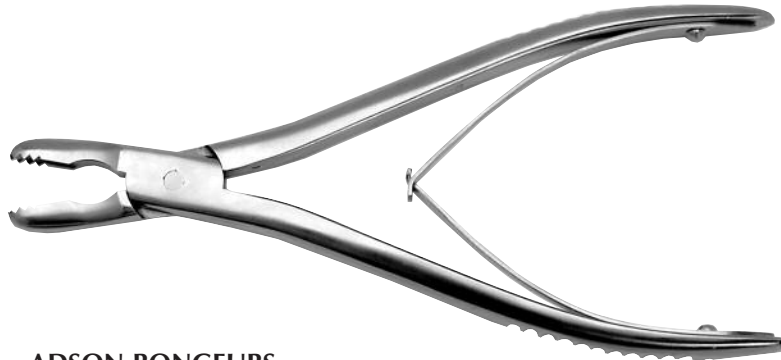

**ADSON RONGEURS**  
8" length 200mm

8mm smooth	834-0818-0
8mm teeth	834-0808-0

## ZIELKE RONGEUR

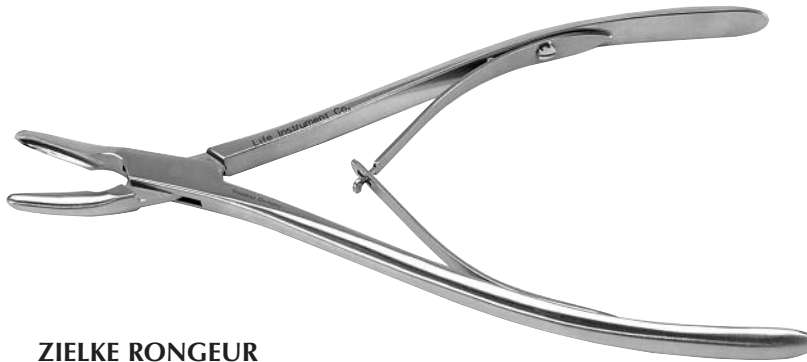

**ZIELKE RONGEUR**  
8" length 200mm

5mm	835-0705-1
-----	------------

## BEYER RONGEUR



**BEYER RONGEUR**  
7" length 175mm

3mm Curved	834-0703-1
------------	------------

**RUSKIN RONGEUR**  
9" length 230mm

6mm Straight	834-0916-0
6mm Angled	834-0916-1

## MAZUR RONGEUR

Unique patented concave tip allows sculpturing of anterior cervical spine without clogging. Improves strength of construct. Allows working in tight spaces.

Designed by John B. Mazur, MD



### MAZUR RONGEUR

MR-001 Large 9" length  
MR-002 Small 7" length

*Available in 2 sizes.*

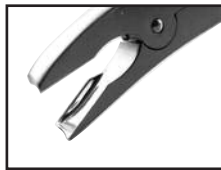

## SMITH PETERSON RONGEURS



### SMITH PETERSON RONGEURS 9" length 230mm

SIZE	STRAIGHT	ANGLED
2mm	836-9502-0	836-9502-1
4mm	836-9504-0	836-9504-1
6mm	836-9506-0	836-9506-1
7mm	836-9507-0	836-9507-1

## STILLE HORSLEY BONE CUTTER

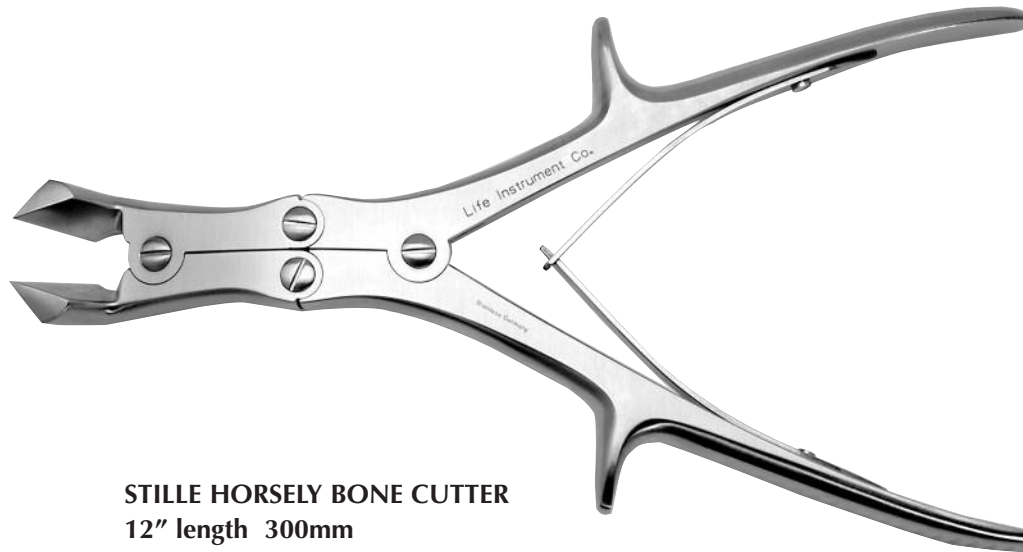

**STILLE HORSELY BONE CUTTER**  
12" length 300mm

836-1212-0

## ANTERIOR DOUBLE ACTION RONGEURS



**ANTERIOR DOUBLE ACTION RONGEURS**  
14" length 355mm

5mm	873-1405-0
8mm	873-1408-0
12mm	873-1412-0

**With teeth**

5mm	873-1405-0T
8mm	873-1408-0T
12mm	873-1412-0T

TO ORDER, CALL 800-925-2995