

## ZELPI® RETRACTORS

The Zelpi Retractor features a unique locking mechanism that guarantees against slipping and provides a 5" minimum exposure. The Zelpi comes with varying length arms to accommodate differing patient anatomy. The varying length arms provide limited pressure on muscles and tissues to help reduce tissue necrosis. The blades are angled at 90°. This design is low profile, providing less bulk in the surgeon's work area than the conventional crank retractors.

The Zelpi Retractors are cost effective, eliminating the cost of expensive multi blade retractor systems.

Left Handed Zelpi Retractors available upon request. Zelpis can be ordered with the locking mechanism reversed for easier use for a left handed person.



### ZELPI RETRACTORS 90° 5" Minimum Exposure

3"	741-1230-2
4"	741-1240-2
5"	741-1250-2

#### Also available

1.5"	741-1215-2
2"	741-1220-2

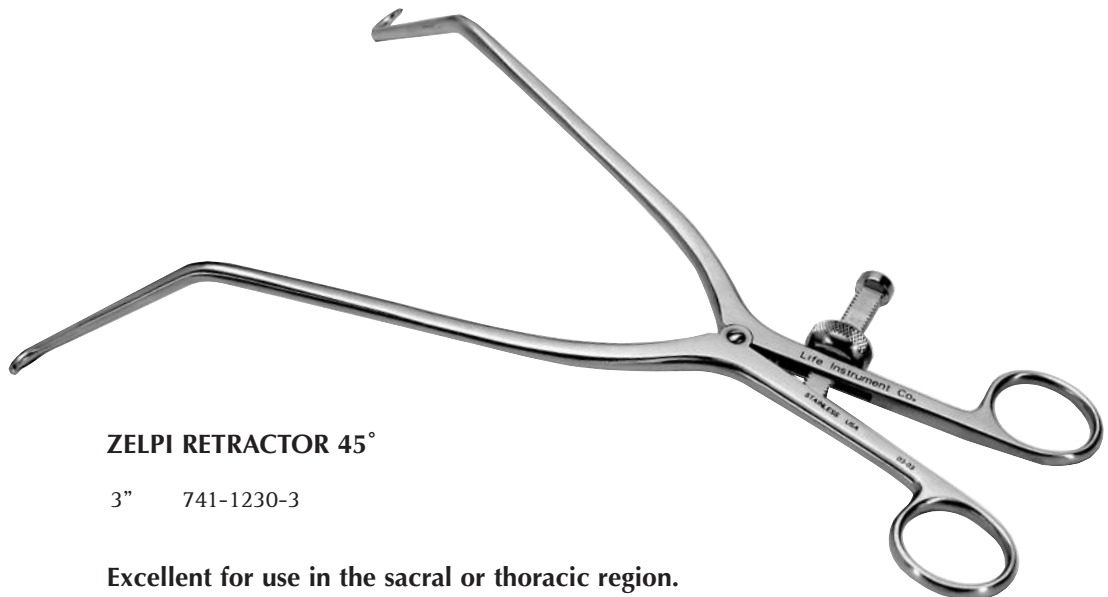

### ZELPI RETRACTOR 45°

3"	741-1230-3
----	------------

Excellent for use in the sacral or thoracic region.

## LATERAL PLIF RETRACTORS

The Lateral Plif Retractor provides greater exposure enabling the surgeon to retract past the transverse process. The retractor comes with a tommy bar wrench that assists with extra torque to attain the 7" maximum exposure.



### LATERAL PLIF RETRACTORS 7" Maximum Exposure

3" 90°	741-1330-1
4" 90°	741-1340-1
Wrench	741-1330-5

## ZELPI® RETRACTORS

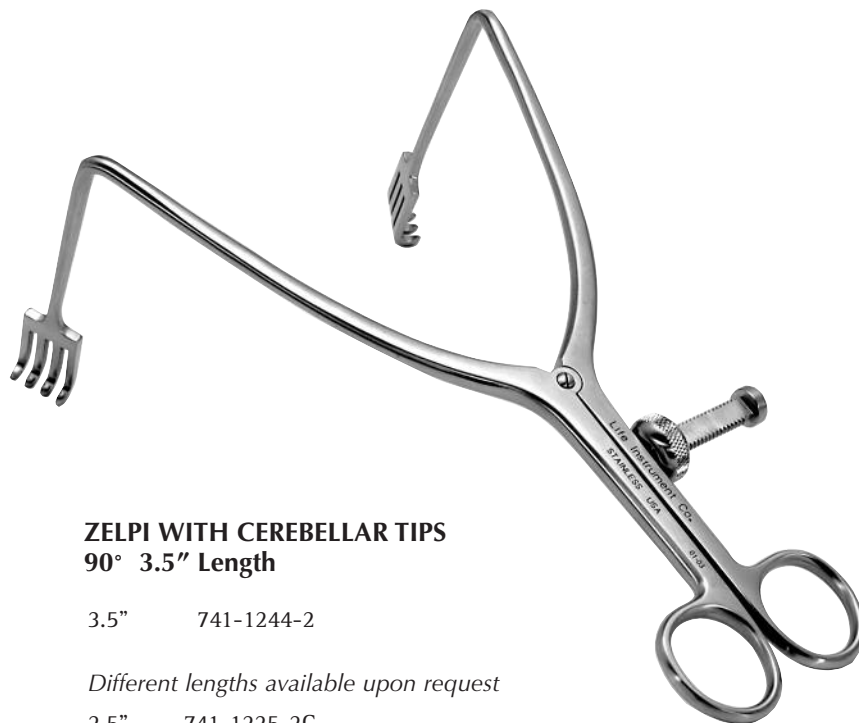

**ZELPI WITH CEREBELLAR TIPS**  
**90° 3.5" Length**

3.5" 741-1244-2

*Different lengths available upon request*

2.5"	741-1225-2C
3"	741-1234-2C
4"	741-1244-2C
5"	741-1254-2C
6"	741-1246-2C



**ZELPI WITH CEREBELLAR TIPS**  
**45° 3.5" Length**

741-1244-3

### OFFSET ZELPI RETRACTORS

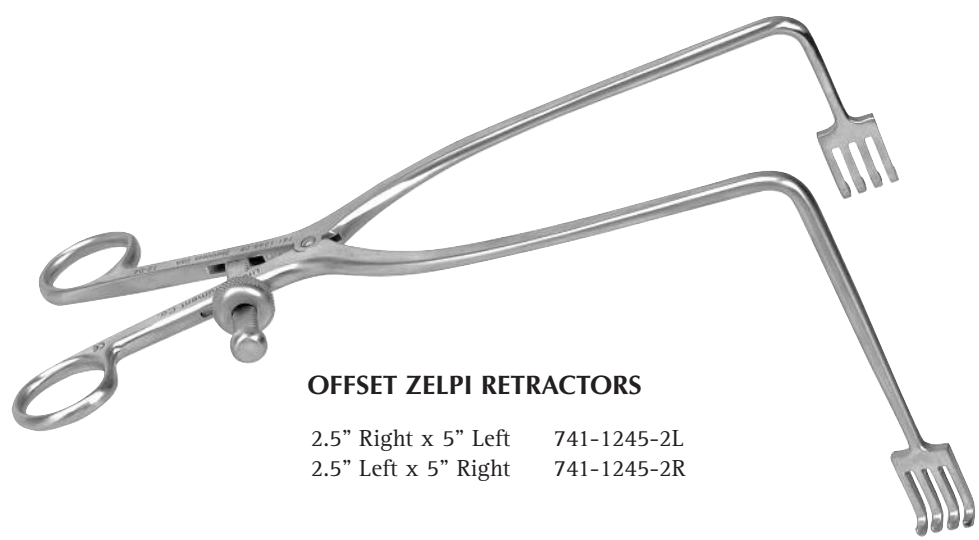

#### OFFSET ZELPI RETRACTORS

2.5" Right x 5" Left    741-1245-2L  
 2.5" Left x 5" Right    741-1245-2R

### DOUBLE PRONG ZELPI RETRACTOR

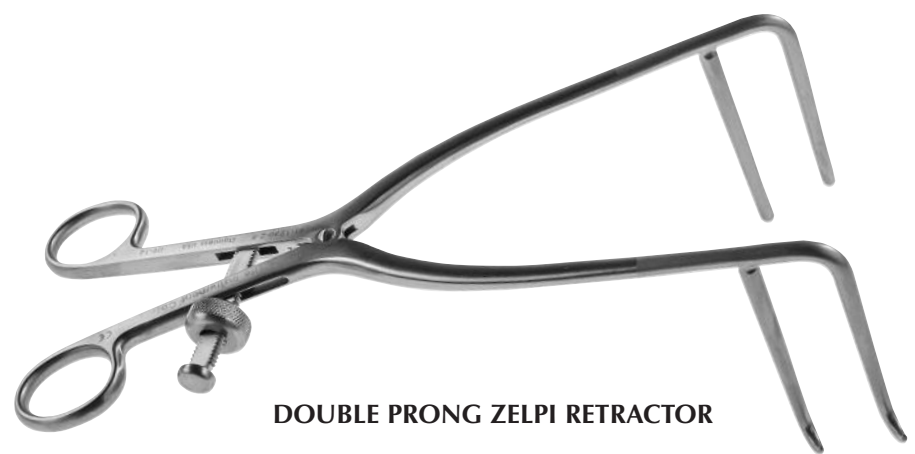

#### DOUBLE PRONG ZELPI RETRACTOR

3" Deep    741-1230-2-8

### DEEP ZELPI RETRACTOR

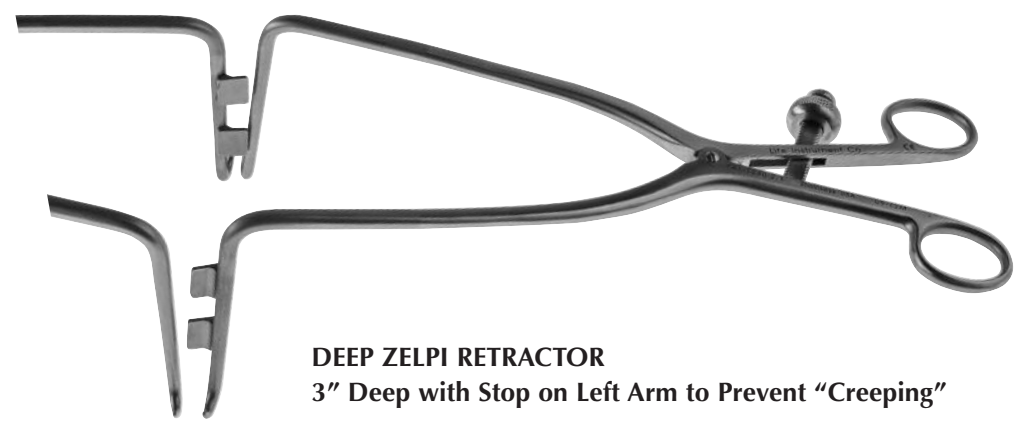

#### DEEP ZELPI RETRACTOR

3" Deep with Stop on Left Arm to Prevent "Creeping"

741-1230-2-1

TO ORDER, CALL 800-925-2995

## GELPI RETRACTORS



**ZELPI CEREBELLAR 90°  
GELPI STYLE RATCHET**

3" 741-1234-2-1



**WILTSE GELPI RETRACTOR 4"**

741-1240-0

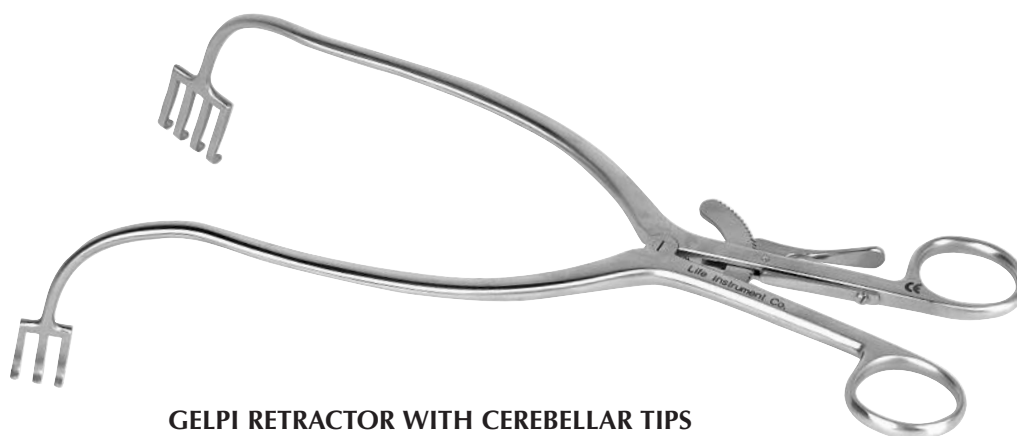

**GELPI RETRACTOR WITH CEREBELLAR TIPS**

741-1241-0

## LARGE GELPI RETRACTOR



**LARGE GELPI RETRACTOR**

3" 741-1230-0 70°

## DEEP GELPI RETRACTOR 3"



**DEEP GELPI RETRACTOR 3"**

90° 741-1030-0

*Different lengths available upon request*

## MISKIMMON RETRACTOR



**MISKIMMON RETRACTOR**  
8" Length 200mm

741-0701-0

TO ORDER, CALL 800-925-2995

## MEYERDING RETRACTOR



**MEYERDING RETRACTOR**  
7.5" Length 190mm

2 3/8" x 1" (60 x 25mm) 741-0705-0

## GELPI RETRACTOR

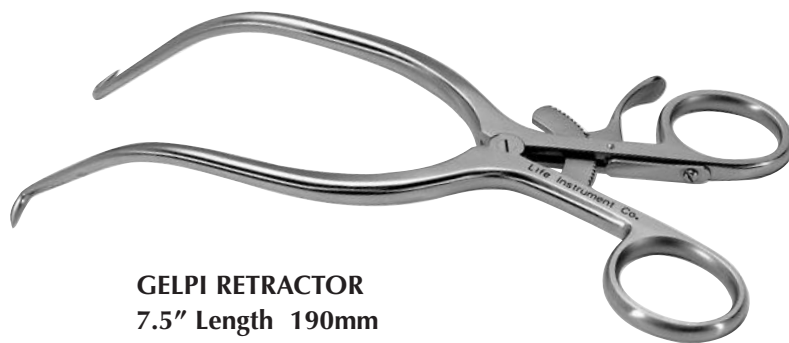

**GELPI RETRACTOR**  
7.5" Length 190mm

741-1010-0

## WEITLANDER RETRACTORS



**WEITLANDER RETRACTORS**  
3 x 4 prongs

**SIZE**

5 1/2"	741-5501-0
6 1/2"	741-6500-0
7 3/4"	741-7750-0
9"	741-0900-0

### ADSON CEREBELLAR RETRACTORS



**ADSON CEREBELLAR RETRACTORS**  
7.5" Length 190mm

- Sharp 741-0702-0
- Blunt 741-0702-0B

### ANGLED ADSON CEREBELLAR RETRACTORS

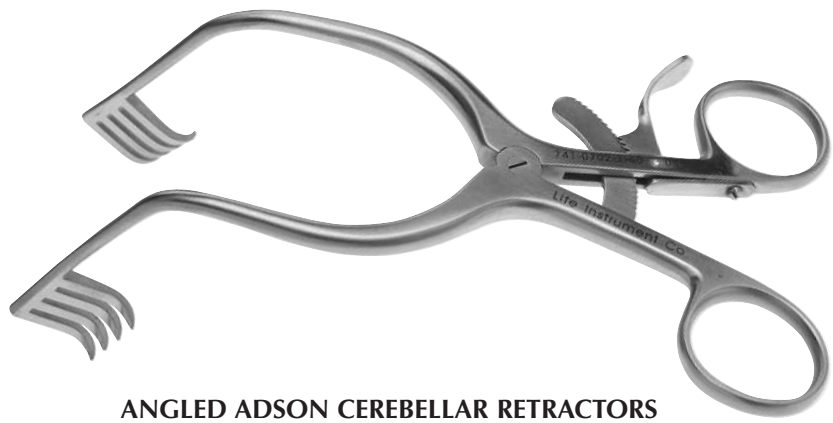

**ANGLED ADSON CEREBELLAR RETRACTORS**  
Sharp Tips

- 60° 741-0702-1-60
- 90° 741-0702-1-90

*Blunt teeth available upon request.*



TO ORDER, CALL 800-925-2995



## WILLIAMS RETRACTORS



### WILLIAMS RETRACTORS Micro Dissectomy Retractor

#### SIZE

10mm x 70mm Left	741-0713-1
10mm x 70mm Right	741-0713-2
20mm x 70mm Left	741-0703-1
20mm x 70mm Right	741-0703-2

#### SIZE

10mm x 50mm Left	741-0513-1
10mm x 50mm Right	741-0513-2
20mm x 50mm Left	741-0503-1
20mm x 50mm Right	741-0503-2

*Left/Right denotes blade side*

## DUCKER RETRACTORS

### DUCKER RETRACTORS

50mm x 20mm Left	741-0750-1
50mm x 20mm Right	741-0750-2
70mm x 20mm Left	741-0770-1
70mm x 20mm Right	741-0770-2



### DOUBLE DUCKER RETRACTORS Double open blade - Interlocking

60mm x 21mm	741-0960-0
73mm x 21mm	741-0973-0
90mm x 21mm	741-0990-0



# ILIAC CREST RETRACTORS



## ILIAC CREST RETRACTORS

Adult           740-9030-0  
 Pediatric       740-8015-0

# MCELROY RETRACTORS

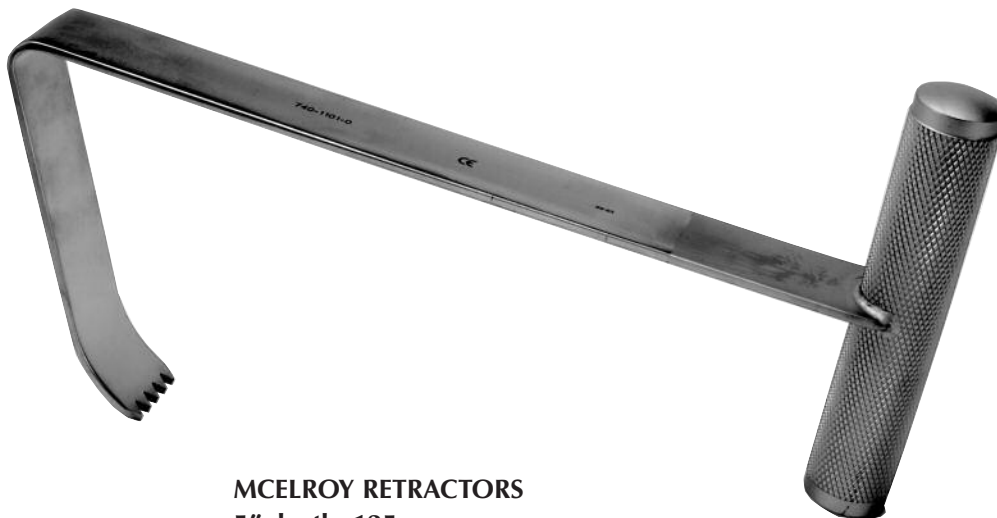

## MCELROY RETRACTORS

5" depth 125mm

**SIZE**  
 9"           740-0901-0  
 11"         740-1101-0  
 13"         740-1301-0 Extra Long

TO ORDER, CALL 800-925-2995

## MEYERDING RETRACTORS

### MEYERDING RETRACTORS

#### SIZE

17mm x 55mm	748-0917-0
25mm x 80mm	748-0925-0
25mm x 125mm	748-0925-L
25mm x 150mm	748-0925-LC
50mm x 94mm	748-0950-0

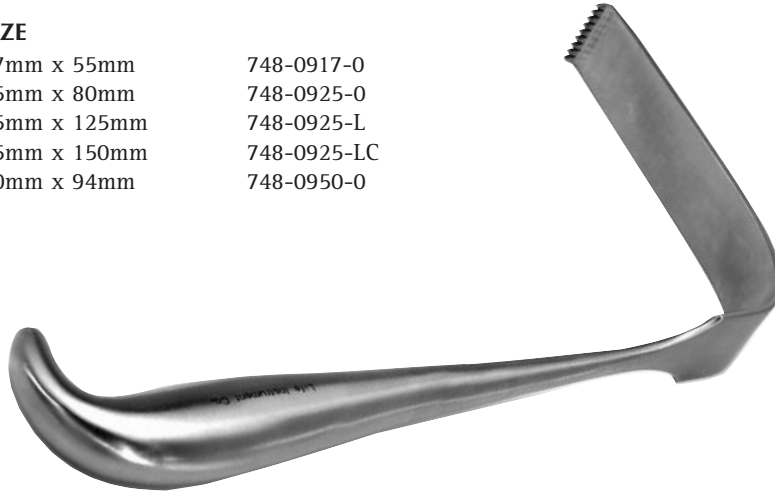

## RIGHT ANGLE RETRACTORS

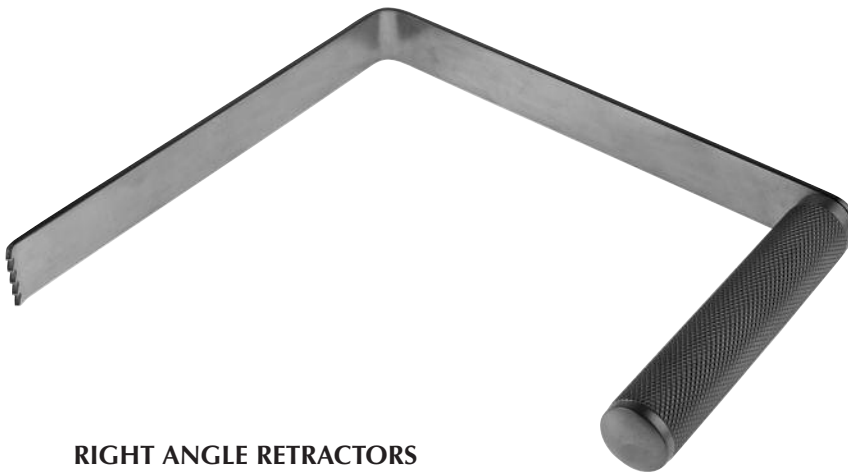

### RIGHT ANGLE RETRACTORS

4"	748-0804-0
6"	748-0806-0
8"	748-0808-0

*Handle can be 90° reversed upon request.*

# TAYLOR RETRACTORS



## MICRO TAYLOR RETRACTORS Blade width *only* 3/4" 19mm

### SIZE

2" 50mm	748-9512-0
3" 75mm	748-9513-0
4" 100mm	748-9514-0
5" 125mm	748-9515-0
6" 150mm	748-9516-0



## CONCAVE MICRO TAYLOR RETRACTOR

3"	748-9523-1
4"	748-9524-1



## FIBEROPTIC MICRO TAYLOR RETRACTORS

3" 75mm	748-9513-1
4" 100mm	748-9514-1

### ACMI Fitting



## TAYLOR RETRACTORS Blade width 1 1/4" 30mm

3" 75mm	748-9503-0
4" 100mm	748-9504-0
6" 150mm	748-9506-0

## RADIOLUCENT PEEK CERVICAL RETRACTOR SYSTEM



### RADIOLUCENT PEEK CERVICAL RETRACTOR SYSTEM

748-0001-P

**\* Quick Connect Feature Holds Blade in Frame \***

Catalog #	Quantity	Description
748-1000-P	1	Transverse Retractor Frame Double Hinged Arms with Peek Connector
748-2000-P	1	Longitudinal Counter Retractor Frame Double Hinged Arms with Peek Connector
748-0030-1	2	Peek Blade Toothed 30mm
748-0035-1	2	Peek Blade Toothed 35mm
748-0040-1	2	Peek Blade Toothed 40mm
748-0045-1	2	Peek Blade Toothed 45mm
748-0050-1	2	Peek Blade Toothed 50mm
748-0055-1	2	Peek Blade Toothed 55mm
748-0060-1	2	Peek Blade Toothed 60mm
748-0065-1	2	Peek Blade Toothed 65mm
748-0030-2	2	Peek Blade Blunt 30mm
748-0035-2	2	Peek Blade Blunt 35mm
748-0040-2	2	Peek Blade Blunt 40mm
748-0045-2	2	Peek Blade Blunt 45mm
748-0050-2	2	Peek Blade Blunt 50mm
748-0055-2	2	Peek Blade Blunt 55mm
748-0060-2	2	Peek Blade Blunt 60mm
748-0065-2	2	Peek Blade Blunt 65mm
748-0700-0	2	Blade Holders
748-0000-PT	1	Sterilization Tray for Peek Cervical Retractor

# CERVICAL INSTRUMENTS



Special Peek Connector enables radiolucency in the AP plane.



### PEEK BLADES

Non-rotating

	TOOTHED	BLUNT
30mm	748-0030-1	748-0030-2
35mm	748-0035-1	748-0035-2
40mm	748-0040-1	748-0040-2
45mm	748-0045-1	748-0045-2
50mm	748-0050-1	748-0050-2
55mm	748-0055-1	748-0055-2
60mm	748-0060-1	748-0060-2
65mm	748-0065-1	748-0065-2



748-1000-P

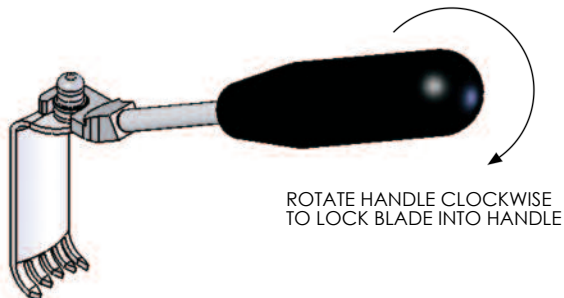

ROTATE HANDLE CLOCKWISE TO LOCK BLADE INTO HANDLE

### BLADE HOLDER

748-0700-0

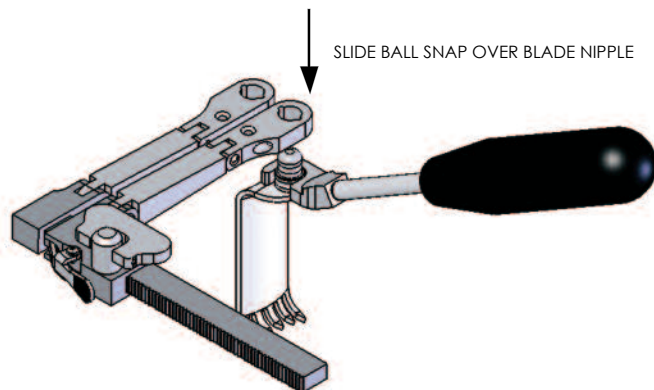

SLIDE BALL SNAP OVER BLADE NIPPLE

TO ORDER, CALL 800-925-2995

## SMALL RADIOLOGENT CERVICAL RETRACTOR SYSTEM

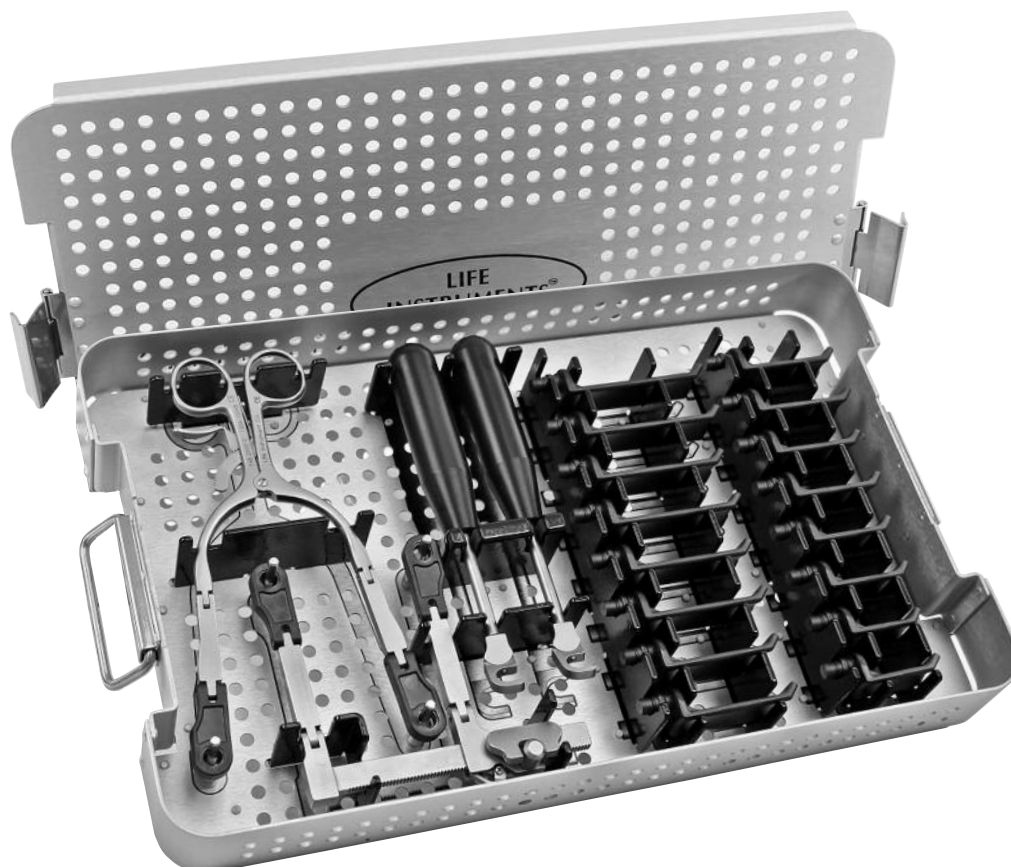

### SMALL RADIOLOGENT CERVICAL RETRACTOR SYSTEM

Holds 16 Blades (Mix and Match)

748-0000-P

**\* Great for Labs or Auxiliary Sets \***



**TRANSVERSE RETRACTOR FRAME  
WITH PEEK CONNECTOR**

748-1000-P



**LONGITUDINAL RETRACTOR FRAME  
WITH PEEK CONNECTOR**

748-2000-P

# ANTERIOR CERVICAL RETRACTOR SYSTEM

*\* Titanium Blades \**

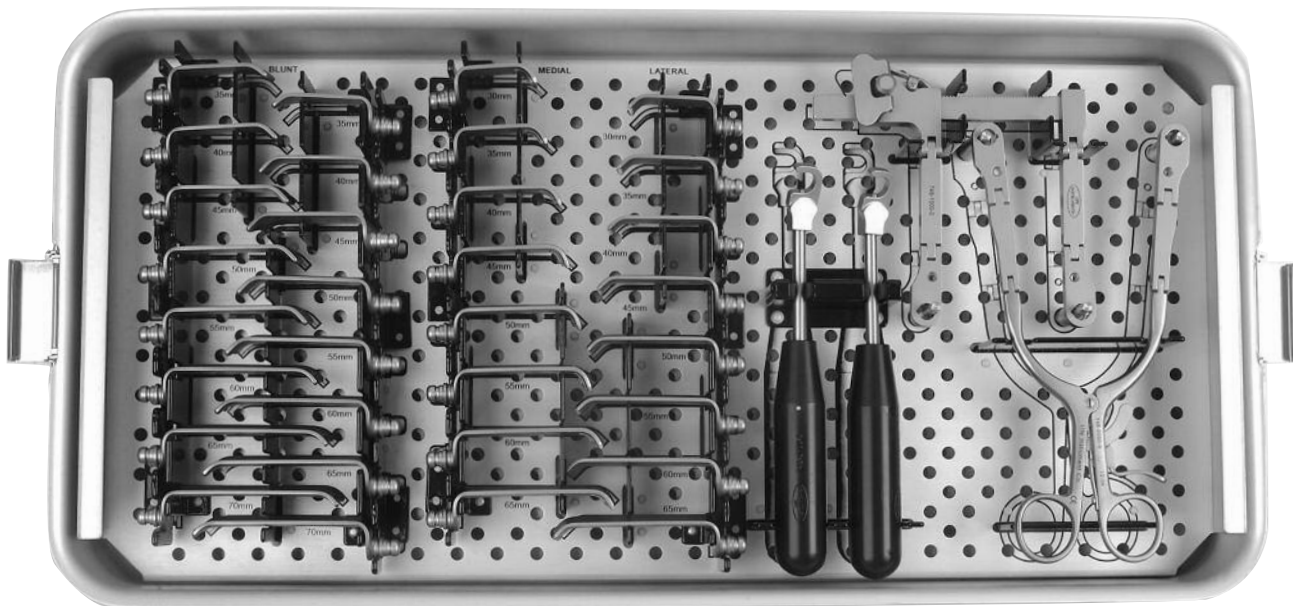

## RETRACTOR SYSTEM

748-0000-0

For complete system information please see pages 11.11 and 11.12

Catalog #	Quantity	Description
748-1000-0	1	Transverse Retractor Frame Double Hinged Arms
748-2000-0	1	Longitudinal Counter Retractor Frame Double Hinged Arms
748-1030-1	1	Retractor Blade Medial 30x23 Toothed Titanium
748-1035-1	1	Retractor Blade Medial 35x23 Toothed Titanium
748-1040-1	1	Retractor Blade Medial 40x23 Toothed Titanium
748-1045-1	1	Retractor Blade Medial 45x23 Toothed Titanium
748-1050-1	1	Retractor Blade Medial 50x23 Toothed Titanium
748-1055-1	1	Retractor Blade Medial 55x23 Toothed Titanium
748-1060-1	1	Retractor Blade Medial 60x23 Toothed Titanium
748-1065-1	1	Retractor Blade Medial 65x23 Toothed Titanium
748-1035-2	2	Retractor Blade 35x23 Blunt Titanium
748-1040-2	2	Retractor Blade 40x23 Blunt Titanium
748-1045-2	2	Retractor Blade 45x23 Blunt Titanium
748-1050-2	2	Retractor Blade 50x23 Blunt Titanium
748-1055-2	2	Retractor Blade 55x23 Blunt Titanium
748-1060-2	2	Retractor Blade 60x23 Blunt Titanium
748-1065-2	2	Retractor Blade 65x23 Blunt Titanium
748-1070-2	2	Retractor Blade 70x23 Blunt Titanium
748-1030-3	1	Retractor Blade Lateral 30x23 Toothed Titanium
748-1035-3	1	Retractor Blade Lateral 35x23 Toothed Titanium
748-1040-3	1	Retractor Blade Lateral 40x23 Toothed Titanium
748-1045-3	1	Retractor Blade Lateral 45x23 Toothed Titanium
748-1050-3	1	Retractor Blade Lateral 50x23 Toothed Titanium
748-1055-3	1	Retractor Blade Lateral 55x23 Toothed Titanium
748-1060-3	1	Retractor Blade Lateral 60x23 Toothed Titanium
748-1065-3	1	Retractor Blade Lateral 65x23 Toothed Titanium
748-0700-0	2	Blade Holders
748-0000-T	1	Sterilization Tray: Includes Outer Tray and Lid, 1 Level Insert

\* See page 11.15 for Micro Titanium Blades 14mm width

TO ORDER, CALL 800-925-2995



## CLOWARD CERVICAL RETRACTORS



### CLOWARD CERVICAL RETRACTORS

#### SIZE

13mm (no lip)	748-7513-0
18mm	748-7518-0
20mm	748-7520-0
23mm	748-7523-0
40mm	748-7540-0

## MODIFIED CLOWARD CERVICAL RETRACTORS



### MODIFIED CERVICAL RETRACTORS

18mm without lip	748-7518-0C
20mm without lip	748-7520-0C
23mm without lip	748-7523-0C

## CERVICAL RETRACTORS

### CERVICAL RETRACTORS WITH DOUBLE FINGER HOLD 3" depth 75mm

Serrated	743-0603-0
Smooth	743-0613-0



### CERVICAL DISTRACTORS



#### CASPAR STYLE DISTRACTORS

- Right Distractor 743-1000-1
- Left Distractor 743-1000-2



#### HINGED DISTRACTOR

#### HINGED DISTRACTOR

743-1011-0

### CERVICAL DISTRACTION SCREW RETRACTOR BLADE



#### CURVED CERVICAL DISTRACTION RETRACTOR BLADE

749-0018-1



Fits over Caspar Screw  
Does not interfere  
with Distractor



#### CERVICAL DISTRACTION SCREW RETRACTOR BLADE

749-0018-0

TO ORDER, CALL 800-925-2995

## CERVICAL DISTRACTION SCREW



### CERVICAL DISTRACTION SCREW

SIZE	SINGLE	PACK OF 10
12mm	743-0012-0	743-0012-P10
14mm	743-0014-0	743-0014-P10
16mm	743-0016-0	743-0016-P10

*\* Non-Sterile \**

## DISTRACTION SCREWDRIVER



### DISTRACTION SCREWDRIVER

743-1001-0

## CALIPER

### CALIPER

749-1090-0

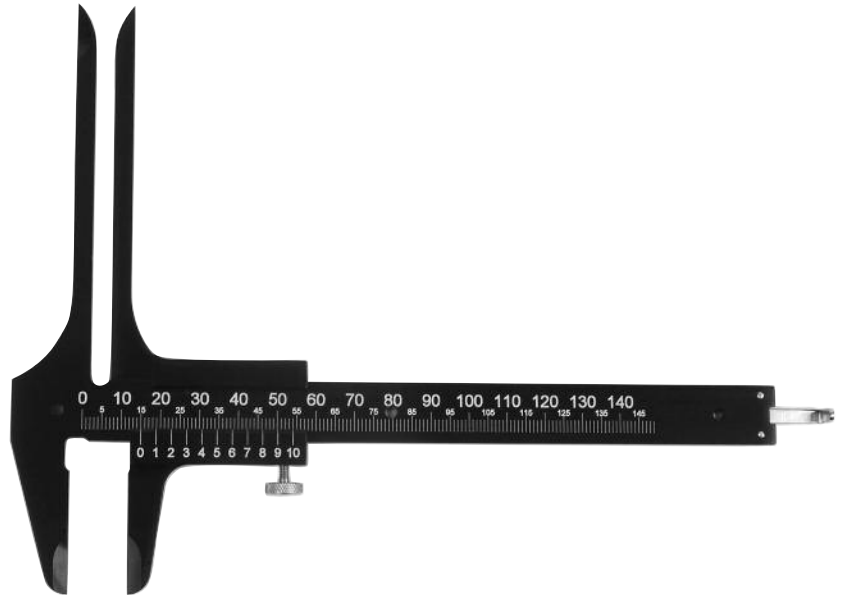

## TWIST DRILL



### TWIST DRILL

743-1003-0

## DRILL GUIDE

### DRILL GUIDE

Drill Guide Right	743-1002-1
Drill Guide Left	743-1002-2

